

OPERATION

Central ventilation unit with heat recovery / Integral system with air/water heat pump for central DHW heating and heating

- » LWZ 8 CS Premium
- » LWZ 5 CS Premium
- » LWZ 5 S Plus
- » LWZ 8 S Trend
- » LWZ 5 S Trend
- » LWZ 5 S Smart

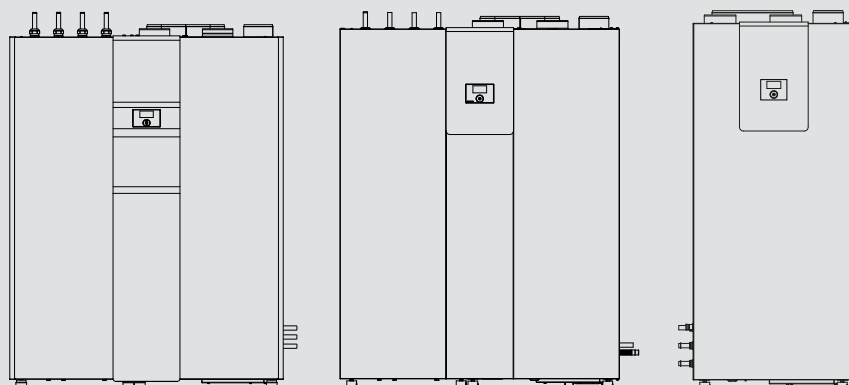

STIEBEL ELTRON

SPECIAL INFORMATION

OPERATION

1. General information	3
1.1 Safety instructions	3
1.2 Other symbols in this documentation	3
1.3 Units of measurement	3
2. Safety	3
2.1 Intended use	3
2.2 General safety instructions	3
2.3 Test symbols	4
3. Appliance description	4
4. Operation	4
4.1 Controls	4
4.2 Operating modes	6
4.3 Favourites, quick access, function block	7
4.4 Entering parameters	7
4.5 Main menu	8
■ INFO	8
■ DIAGNOSIS	8
□■ SYSTEM STATUS	8
□■ FAULT LIST	8
■ PROGRAMS	8
□■ HEATING PROGRAM	8
□■ DHW PROGRAM	9
□■ FAN PROGRAM	9
□■ HOLIDAY PROGRAM	9
□■ PARTY PROGRAM	9
■ SETTINGS	10
□■ HEATING	10
□■ DHW	11
□■ VENTILATION	12
□■ COOLING	12
□■ SOLAR THERMAL	13
□■ SCREED DRYING PROG.	14
□■ COMMISSIONING	14
□■ TIME / DATE	14
□■ CONTRACTOR	14
5. Cleaning, care and maintenance	15
5.1 Replacing supply air and extract air filters	15
5.2 Replacing the outdoor air filter	16
5.3 Cleaning the extract and supply air vent filters	16
6. Troubleshooting	16
6.1 Filter symbols appear	16
6.2 No hot water	16
6.3 The safety valve of the cold water supply line is dripping	16
6.4 The fault symbol appears	16
6.5 The appliance leaks water	16
6.6 Condensate on the outside of the appliance or on the air hoses	16
6.7 Noise is emitted	16
6.8 The required flow temperatures are not reached, particularly during drying out	17
6.9 The accommodation is always too cold	17

6.10 The accommodation is always too hot	17
6.11 The accommodation is too cold in winter	17
6.12 The accommodation is too hot in winter	17
6.13 The accommodation is too cold in spring and autumn	17
6.14 The accommodation is too hot in spring and autumn	17
6.15 The accommodation is too hot in summer	17
6.16 Air quality is too poor	17
6.17 The air in winter is too dry	17
7. Menu structure	18

GUARANTEE

ENVIRONMENT AND RECYCLING

SPECIAL INFORMATION

- The appliance may be used by children aged 8 and older and persons with reduced physical, sensory or mental capabilities or a lack of experience and know-how, provided that they are supervised or they have been instructed on how to use the appliance safely and have understood the potential risks. Children must never play with the appliance. Children must never clean the appliance or perform user maintenance unless they are supervised.

OPERATION

1. General information

This manual is intended for the appliance user and qualified contractors.



Note
Read these instructions carefully before using the appliance and retain them for future reference.
Pass on the instructions to a new user if required.

1.1 Safety instructions

1.1.1 Structure of safety instructions



KEYWORD Type of risk
Here, possible consequences are listed that may result from failure to observe the safety instructions.
► Steps to prevent the risk are listed.

1.1.2 Symbols, type of risk

Symbol	Type of risk
	Injury
	Electrocution
	Burns (burns, scalding)

1.1.3 Keywords

KEYWORD	Meaning
DANGER	Failure to observe this information will result in serious injury or death.
WARNING	Failure to observe this information may result in serious injury or death.
CAUTION	Failure to observe this information may result in non-serious or minor injury.

1.2 Other symbols in this documentation



Note
Notes are bordered by horizontal lines above and below the text. General information is identified by the adjacent symbol.
► Read these texts carefully.

Symbol	Meaning
	Material losses (appliance damage, consequential losses and environmental pollution)
	Appliance disposal

► This symbol indicates that you have to do something. The action you need to take is described step by step.

□ □ ■ These symbols show you the software menu level (in this example level 3).

1.3 Units of measurement



Note
All measurements are given in mm unless stated otherwise.

2. Safety

2.1 Intended use

The appliance is a complete system with the following functions:

	LWZ 8 CS Premium / LWZ 5 CS Premium	LWZ 5 S Plus	LWZ 8 S Trend / LWZ 5 S Trend	LWZ 5 S Smart
Centralised ventilation with heat recovery	x	x	x	-
Central DHW provision	x	x	x	x
DHW cylinder integrated into the appliance	x	x	-	x
Connection of an external DHW cylinder	x	-	x	-
Heating	x	x	x	x
Cooling	x	-	-	-
Connection of thermal solar collectors	x	-	-	-

The appliance is intended for domestic use. It can be used safely by untrained persons. The appliance can also be used in non-domestic environments, e.g. in small businesses, as long as it is used in the same way. Any other use beyond that described shall be deemed inappropriate. Observation of these instructions is also part of the correct use of this appliance.

2.2 General safety instructions

The appliance should only be operated once it is fully installed and all safety equipment has been fitted.



WARNING Electrocution
Never splash the appliance with water or other liquids.



WARNING Burns
There is a risk of scalding at outlet temperatures in excess of 43 °C.



WARNING Injury
The discharged cold air can cause condensation to be formed in the vicinity of the air discharge.
► Ensure that no risk of slipping due to wet conditions or ice formation occurs on adjacent footpaths and driveways at low temperatures.

Appliance description



WARNING Injury

The appliance may be used by children over 8 years of age and persons with reduced physical, sensory or mental capabilities or a lack of experience and expertise, provided that they are supervised or they have been instructed on how to use the appliance safely and have understood the potential risks. Children must never play with the appliance. Children must never clean the appliance or perform user maintenance unless they are supervised.



Note

Do not change any system-specific settings at the control unit. Your qualified contractor has set the control unit to match the local conditions for your building and your individual requirements. The system-specific parameters are protected by a code to prevent unintentional modifications.

The parameters that serve to adapt the appliance to your personal requirements are not protected by a code.

Appliances with ventilation function



WARNING Injury

If there is a radio or police announcement ordering windows and doors to be kept closed, simply select fan stage "0" (= fan off) for several hours.

The programming unit must be activated if the appliance has been out of operation for a long time:

- ▶ Hold down "MENU" button for three seconds.
- ▶ If you have already navigated through the menu tree, pressing MENU will return you to the default display. If necessary you may have to press menu several times.
- ▶ Slide your finger along the scroll wheel until you reach the "VENTILATION STAGES" entry.
- ▶ Press "OK".
- ▶ Press "OK" again to adjust the "Unscheduled vent." parameter.
- ▶ Set the "UNSCHEDULED VENT." parameter to 0 by sliding your finger anti-clockwise over the scroll wheel.
- ▶ Confirm with "OK".
- ▶ Set the "UNSCHED. VENT TIME STAGE 0" parameter to a suitable value.

Never adjust the setting of supply and extract air valves inside the rooms. These have been adjusted during commissioning.

2.3 Test symbols

See type plate on the appliance.

3. Appliance description

When there is a heat demand, outdoor air is channelled through the evaporator and its energy extracted. This energy is boosted to a higher temperature level by means of the heat pump, to heat the DHW and the heating system.

When the temperature is very low, or when there is a very high heat demand, the appliance covers the residual heat demand by means of an integral electric emergency/booster heater. With a mono mode design, the electric emergency/booster heater is acti-

vated for emergency heating if the temperature reading falls below the standard outside temperature, set as the dual mode point. This ensures heating operation and the provision of high DHW temperatures. In mono energetic mode, the electric emergency/booster heater is activated as a booster heater.

The appliance is controlled by a weather-compensated control unit.

Appliances with ventilation function

Heat is recovered from the extract air via a highly efficient cross-countercurrent heat exchanger. The cooled air is discharged outdoors as exhaust air.

Appliances with solar heat exchanger

An additional heat exchanger is included in the common return to the heat pump. The thermal solar collectors connected can back up both DHW heating and room heating. A differential temperature controller for the solar thermal system is integrated in the appliance control unit.

A heat exchanger built into the outdoor air flow heats the outdoor air for domestic ventilation. If sufficient solar heat is available, the outside air is preheated indirectly by solar energy.

Appliances with cooling function

The refrigeration unit of the heat pump may be reversed. In cooling mode, heat can then be extracted from the heating circuit and transferred to the outdoor air.

Inverter

The compressor in the appliance has an electronic speed controller. The compressor adjusts its output to the cooling/heating demand. If the current room temperature is far from the set temperature, the provision of cooling/heating output for the room will be accordingly high. If the temperature differential decreases, the appliance reacts to the change in requirements and provides a lower cooling or heating output. This results in advantages of economy and convenience when compared with appliances without inverter technology, where the compressor either runs at maximum output or is off.

Heat metering

The appliance is equipped with an integral heat meter. In the „INFO“ menu, the supplied amounts of heat are displayed.

4. Operation

4.1 Controls

The programming unit enables you to change parameters and to obtain information on the appliance operation. The appliance can also be controlled when no programming unit is connected or the connected one is faulty. The programming unit comprises the scroll wheel, two keys and above these a display.

OPERATION

Operation

4.1.1 Display

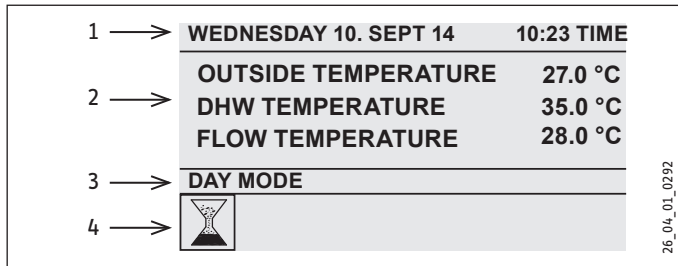



- 1 Date and time
- 2 Favourites When you are in the menu, the favourites display is no longer shown.
- 3 Operating mode, Quick link, Function block
- 4 Appliance status symbols

You can adjust the contrast of the display and select the language of the display texts in the „COMMISSIONING“ menu.

4.1.2 Picture symbols on the display

At the lower edge of the display, symbols provide information about the current appliance operating status. Up to eight symbols can be displayed at once.

 **Filter change, top:**
The extract air filter is contaminated. Please change the extract air filter.

 **Filter change, bottom:**
The supply air filter is contaminated. Please change the supply air filter.

 **Filter change, top and bottom:**
The filter change service intervals of the extract air and the supply air filters have expired or the filters have become contaminated prematurely. Please change the extract air and supply air filters.

 **Electric emergency/booster heater:**
The electric emergency/booster heater has started up. This occurs, for example, when the outside temperature has fallen below the dual mode point.

 **Cooling:**
The cooling symbol is displayed when the appliance is in heating mode.

 **Heating:**
The heating symbol is displayed when the appliance is in heating mode.

 **DHW heating:**
This symbol tells you that the appliance is heating DHW.

 **Compressor:**
The compressor symbol signals that the compressor is running.

 **Evaporator defrost:**
The evaporator is defrosting.

 **Switching program enabled:**
If a switching program is enabled, this symbol is displayed.

 **Service:**
A service is required. Please contact your qualified contractor.

 **Ventilation stage:**
For a limited period the appliance operates with a modified ventilation stage.

 **Heating circuit pump:**
The pump symbol is displayed when a heating circuit pump is running.

 **Heat-up:**
This symbol shows when the dry heating (screed drying) program runs.

 **Power-OFF:**
This symbol lights up if the appliance has no enable signal from the power supply utility.

4.1.3 Scroll wheel

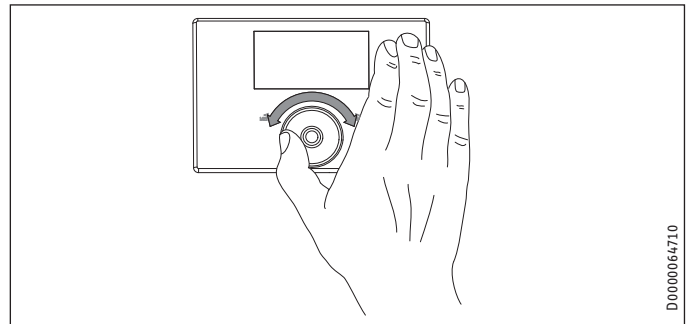

The scroll wheel consists of a touch-sensitive sensor. There is a key to the left and another to the right of it.

 **Note**
If you have gloves on, have wet hands or the programming unit is damp, this impedes the recognition of your touch and the execution of the action you require.

In the „COMMISSIONING“ menu, your qualified contractor can set the touch sensitivity using the „TOUCH SENSITIVITY“ parameter.

Activation

The user interface is blocked to protect the appliance from accidental incorrect adjustments.

- ▶ Touch the menu button for 3 seconds to enable the user interface.

If the scroll wheel and keys are not used for 20 minutes, the programming unit is locked again. With the function block, you can block the user interface for 60 seconds.

Once the programming unit is activated, you have two adjustment options:

- You can select operating modes with the scroll wheel.
- You can press „MENU“ to continue navigating from there to a specific appliance parameter.

Selection indicator

As you move through the menu and parameter levels, the selection indicator shows your current position. Either a dark background appears or the current list entry is highlighted by two lines, one above and one below.

Circular movement

If you brush a finger clockwise along the recessed scroll wheel, the highlighting field moves through the list of parameters either to the right, or downwards if the parameters are arranged vertically. With an anti-clockwise rotation, the highlighter moves to the left or upwards.

Alongside navigation within the menu structure, the scroll wheel is also used to set parameters. If you make a clockwise rotation, the value is raised. With a circular movement anti-clockwise, values are reduced.

Faster circular motions increase the step magnitude when changing parameters. Your qualified contractor can determine at what speed of rotation the step magnitude changes, in the „COMMISSIONING“ menu using the „TOUCH ACCELERATION“ parameter.

4.1.4 Menu key

If you are on the default screen, press „MENU“ to enter the second level of the menu structure. There, you have access to the appliance setting options, such as the input of switching time programs.

If you are not in the highest menu level, tap the menu key to go back one level.



Note

In the following sections of this document, the abbreviation "MENU" means you should touch the MENU key.



Note

Tap the keys only briefly to initiate the required action. If you touch the menu and OK keys for too long, the programming unit will not respond.

4.1.5 OK button

With one touch of the OK key, you confirm the selection of the menu entry highlighted. This brings you into the menu tree on the next menu level. If you are already at the parameter level, „OK“ saves the currently set parameter.

4.2 Operating modes

When the start screen is activated, the current operating mode is displayed. If you want to select another operating mode, scroll with the scroll wheel.

WEDNESDAY 10. SEPT 14		10:23 TIME
OUTSIDE TEMPERATURE		14.0 °C
DHW TEMPERATURE		35.0 °C
ROOM TEMPERATURE		18.0 °C
DAY MODE		
		

26_04_01_0292

<input checked="" type="checkbox"/> Operating modes
<input type="checkbox"/> STANDBY
<input type="checkbox"/> AUTOMATIC
<input checked="" type="checkbox"/> DAY MODE
<input type="checkbox"/> SETBACK MODE
<input type="checkbox"/> DHW MODE
<input type="checkbox"/> MANUAL MODE
<input type="checkbox"/> EMERGENCY MODE

At the end of this selection list, further setting options are available:

<input type="checkbox"/> FAVOURITES
<input type="checkbox"/> VENTILATION STAGES
<input type="checkbox"/> HOTTER / COLDER
<input type="checkbox"/> FUNCTION BLOCK

4.2.1 STANDBY

In standby mode, the appliance delivers the set standby values. Generally, you will switch the appliance into minimum operation with standby mode. The appliance runs in standby mode until another operating mode is enabled.

4.2.2 AUTOMATIC

In automatic mode, the time programs set for central heating, DHW and ventilation are implemented. Automatic mode is the standard appliance setting. The heating flow temperature is regulated according to a weather-compensated heating curve. The appliance runs in setback mode if no time programs are enabled.

4.2.3 DAY MODE

In day mode (generally while occupants are present in the house, during the day), the heating system operates with the selected set day values. Day mode does not influence DHW heating or ventilation.

4.2.4 SETBACK MODE

The appliance activity is reduced in setback mode, for example at night time, or during the day when nobody is at home. In setback mode, the heating system is operated with the selected set night values. Setback mode does not influence DHW heating or ventilation.

OPERATION

Operation

4.2.5 DHW MODE

DHW mode is enabled in accordance with the set time programs. For the current pair of switching times, the DHW set day value is delivered. The central heating is switched off except for frost protection. DHW operation does not influence ventilation.

4.2.6 MANUAL MODE

If manual mode is enabled, the set values selected for manual mode are delivered. In manual mode, the heating flow temperature is not influenced by the outside temperature.

4.2.7 EMERGENCY MODE

If emergency mode is enabled, the „Compressor“ heating stage is skipped. Heating is provided by the solar thermal system (if connected) or the electric emergency/booster heater. The dual mode point is not taken into consideration. Using the electric emergency/booster heater on its own for long periods means high energy costs. If you activate emergency mode, the set room temperatures from automatic mode are used. The switching programs from automatic mode are also used.

In emergency mode, the appliance applies the set temperatures and switching programs from automatic mode for DHW heating.

4.3 Favourites, quick access, function block

4.3.1 FAVOURITES

Up to three parameters are constantly shown on the display when the appliance is in operation. To select your favourites, navigate to the required parameter. If the square at the end of the line is not filled in, this parameter is not yet one of your favourites. Press „OK“ to change this. However, you can only select three favourites. You may therefore have to disable one of your current favourites. Press „OK“ to disable.

4.3.2 Ventilation stages

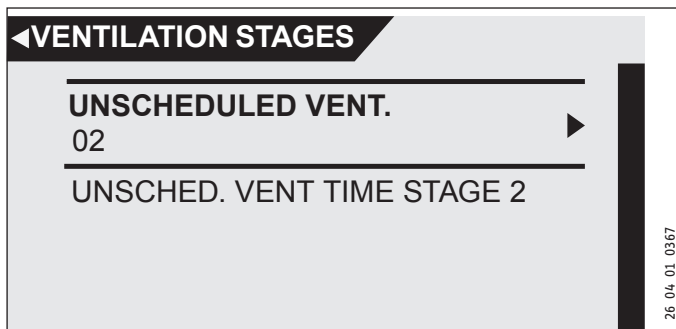

Under „UNSCHEDULED VENT.“ enter the required value (0 to 3). This setting is valid for a limited time, which you set in the neighbouring menu item, e.g. „UNSCHEDED. VENT TIME STAGE 0“. If you do not set a time, the appliance adopts the saved parameter values.

4.3.3 HOTTER / COLDER

Here, you can change the set room temperatures for the heating circuits and thereby raise or lower the heating curves.

4.3.4 FUNCTION BLOCK

If you select the „FUNCTION BLOCK“ function, the programming unit will be blocked for 60 seconds. During this time, you can clean the programming unit without accidentally changing the appliance settings. A counter appears on the screen that shows the remaining blocking time in seconds.

4.4 Entering parameters

Parameters are changed by scrolling with the scroll wheel. To save the new value, touch „OK“. If you want to cancel the entry, press „MENU“.



Note

If more than five minutes pass without any user activity, rotation or tapping of "MENU" or "OK", the programming unit display automatically jumps back to the default screen. Recent parameter changes not yet been confirmed with "OK" will be lost. The parameters retain the values previously saved.

Example 1

To enter set temperatures, a number surrounded by a circle appears on the display. This indicates that you can change the value by turning the scroll wheel.

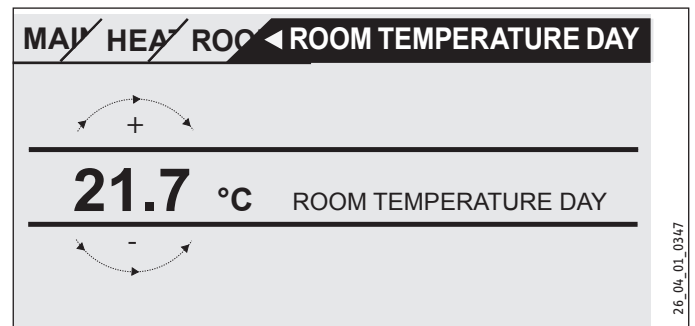

Example 2

To set holiday dates, a calendar page for the selected month appears.

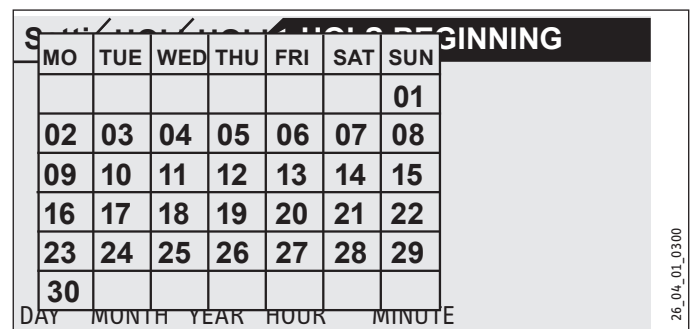

Turning the scroll wheel displays the highlighter that you can then move to the required date.

OPERATION

Operation

Example 3

Some parameters are selected via highlighted boxes. The positions where the box is highlighted, i.e. coloured in black, are active. One example is setting up favourites. With „OK“ you can highlight the box, or remove it if the item was already highlighted. For favourites, up to three highlighted list entries can be selected in this way.

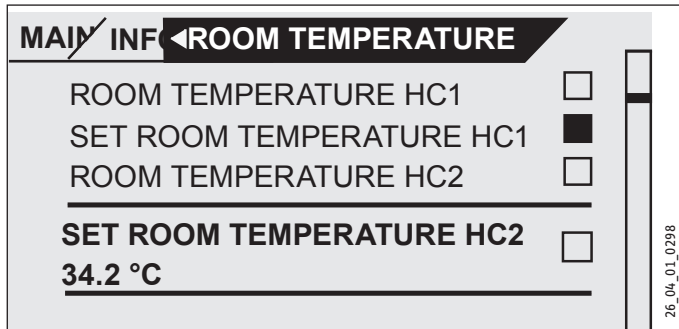

4.4.1 Contractor access

To prevent incorrect adjustments, some appliance parameters may only be changed by qualified contractors. These parameters are protected and can only be changed after entering a code.

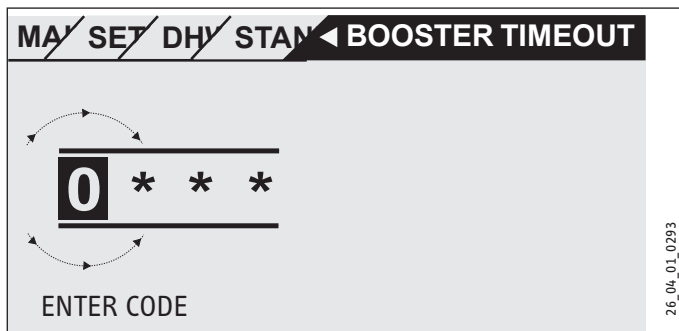

4.5 Main menu



Note

Some menu items are protected by a code and can only be accessed and adjusted by a qualified contractor.

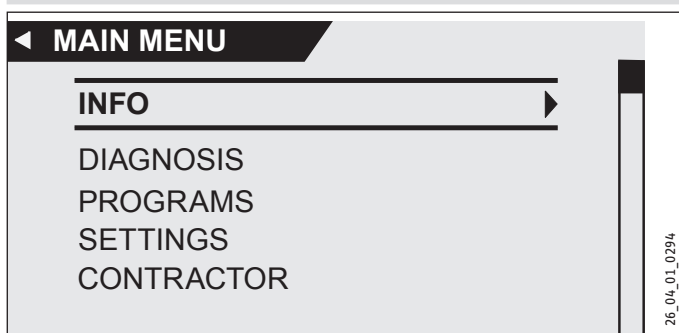

■ INFO

In the „INFO“ menu, actual values are displayed. See the chapter „Menu structure“ for a list of these.

■ DIAGNOSIS

□ ■ SYSTEM STATUS

□ □ ■ POWER-OFF

POWER-OFF indicates whether voltage is present at the power supply utility input. If voltage is present, the power supply utility has not disabled any component of the appliance.

□ □ ■ STOVE / FIREPLACE

□ □ ■ AIR HEAT EXCH. DEFR.

□ □ ■ EVAPORATOR DEFOST

□ ■ FAULT LIST

The fault memory contains the ten most recent fault messages. The display, however, can show only six fault messages at a time. Turn the scroll wheel to access the other entries in the fault memory.

■ PROGRAMS

If automatic mode is set, this is where you define the time programs that control the appliance.

□ ■ HEATING PROGRAM

□ □ ■ HEATING CIRCUIT 1 | HEATING CIRCUIT 2

You can set individual heating programs for heating circuits 1 and 2. This determines when and how often the appliance should operate in day mode. At all other times, the appliance operates in setback mode. You can select the set values for day and setback mode under the menu item „ROOM TEMPERATURES“.

First, select the days on which you want to enable the heating function:

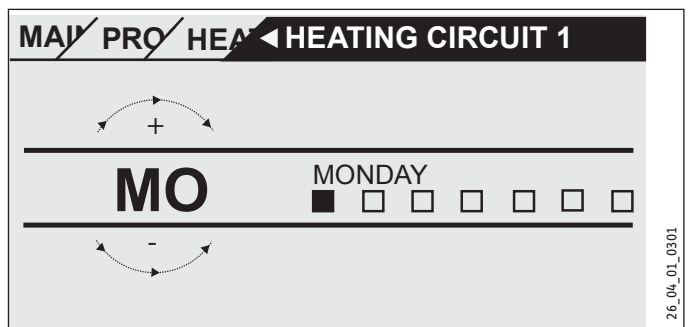

- on individual days („MONDAY“, ... , „SUNDAY“)
- from Monday to Friday („MON - FRI“)
- on Saturday and Sunday („SAT - SUN“)
- throughout the whole week („MON - SUN“)

Monday is initially offered.

- ▶ Select the day or a group of days.
- ▶ Confirm your selection with „OK“.

You can now set three switching time pairs. The three switching time pairs are shown on the display, to the right of the clock. A switching time pair comprises the start time and end point, at which the appliance returns to its previous state.

OPERATION

Operation

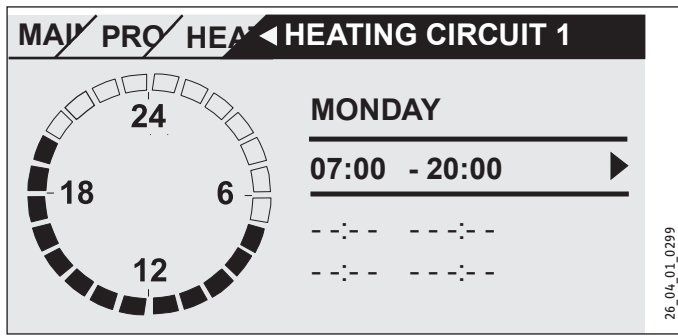

In this example, only one switching time pair has so far been programmed. For switching time pairs 2 and 3, short dashes are displayed instead of times. These switching time pairs are still empty. Select one of the free switching time pairs with „OK“ to reach the area where you can set the associated start and end time. Pressing „OK“ brings up the display shown below. Set the required time.

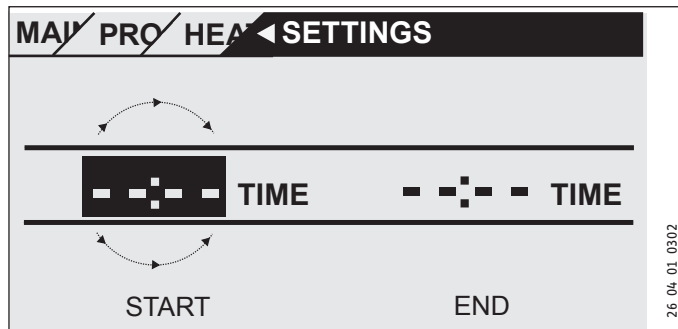

Times can be entered in intervals of 15 minutes. Confirm your entry with OK.

Periods around midnight

Assume, for example, you want heating mode to be enabled from 22:00 h for four hours every Wednesday evening. However, since the day ends at 00:00 h, two switching time pairs are necessary for the required program. First, program the period 22:00 to 00:00 h for Wednesday, then 00:00 to 02:00 h for Thursday.

Deleting a switching times pair

Select the pair of switching times you want to delete. Go to the start time change. Turn the scroll wheel to reduce the time. If you reach 00:00 and continue to make a rotation, the pair of switching times is removed. The previously shown display appears, i.e. dashes instead of numbers. Confirm again with OK.

DHW PROGRAM

Here, you can set the periods when DHW is heated with reference to the set day temperatures. In the other phases, the set night temperatures are followed. You can select the set values for day and night mode as described in the DHW chapter.

Example: You want to heat up DHW daily at two different times, i.e. from 22:00 to 05:00 h the following day, and then again from 08:00 to 11:00 h. Since the day begins at 00:00 h, begin programming at 00:00 h. The first pair of switching times runs from 00:00 to 05:00 h. The second pair of switching times starts at 08:00 h and ends at 11:00 h. The third switching time pair runs from 22:00 to 24:00 h.

The pairs of switching times should be selected so that the DHW cylinder can be completely heated up between the start and stop times (at least 3 hours).

FAN PROGRAM

The setting is made as for the central heating and DHW programs.

HOLIDAY PROGRAM

During the holidays, if nobody is in the house, central heating, DHW and ventilation are not required in their full scope. All set temperatures are set to match the set values of the standby function. Define the first and last days of the holiday. At the end of the holiday, the appliance runs according to the set programs again.

HOLS BEGINNING

DAY

MONTH

YEAR

HOUR

MINUTE

HOLIDAYS ENDING

DAY

MONTH

YEAR

HOUR

MINUTE

PARTY PROGRAM

Under this parameter you can extend day mode for several hours. Enter the start and end time of your party. Times can be set that go beyond the end of the day the party starts.

OPERATION

Operation

■ SETTINGS

□ ■ HEATING

Two heating circuits can be operated with this appliance, e.g. one direct heating circuit for radiator heating system and one heating circuit with mixer for underfloor heating system.

Enter the „ROOM TEMPERATURES HC1“ submenu for settings applicable to the first heating circuit.

□ □ ■ ROOM TEMPERATURES HC1

□ □ ■ ROOM TEMPERATURE DAY HC1

□ □ ■ ROOM TEMP. NIGHT HC1

□ □ ■ ROOM TEMP. STANDBY HC1

□ □ ■ MANUAL SET HC1

□ □ ■ ROOM TEMPERATURE HC1

Select the required set room temperature for day, setback and standby modes.

MANUAL SET HC: Under this parameter, set the heating flow temperature for manual mode.

ROOM TEMPERATURE: This parameter, the display of the current value, is only shown if a room temperature sensor is connected.

□ □ ■ ROOM TEMPERATURES HC2

See chapter „ROOM TEMPERATURES HC1“. Set the values in this submenu accordingly.

□ □ ■ HEATING CURVE HC1

□ □ ■ GRADIENT HC1

□ □ ■ LOW END HC1

□ □ ■ ROOM INFLUENCE HC1

□ □ ■ FLOW PROPORTION HC1

□ □ ■ MAX. SET VALUE HC1

□ □ ■ MIN. SET VALUE HC1

□ □ ■ HEATING CURVE HC1

The room temperature will only remain constant irrespective of the outside temperature if the correct heating curve has been selected for the relevant type of building. Selecting the correct heating curve is therefore vitally important. The more precisely the heating curve is set, the more economically the appliance works. Try therefore to optimise your heating curve. Reduce the current heating curve until the flow temperature is just sufficient for heating. The target is as flat a heating curve as possible.

- ▶ Fully open thermostatic valves (remove head) in a lead room, for example living room or bathroom.
- ▶ At different outside temperatures, adjust the heating curve so the required temperature is set in the lead room (living room or bathroom). Now the room temperature in these rooms is controlled with the heating curve (see next diagram).

Standard values to begin with:

Parameter	Underfloor heating	Radiator heating system
□ □ ■ GRADIENT	0.4	0.8
□ □ ■ LOW END	K 3	10
□ □ ■ ROOM TEMPERATURE DAY	°C 20	20

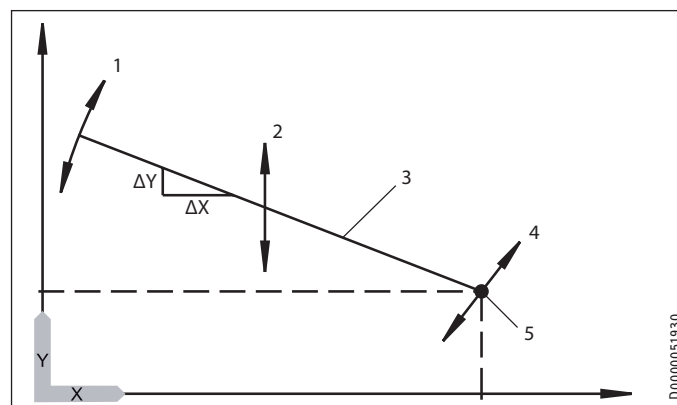

X Outside temperature [°C]

Y Heating circuit temperature sensor [°C]

1 Gradient influence

$$\text{Gradient} = \Delta Y / \Delta X$$

= Heating circuit temperature change / Outside temperature change

2 Low end offset influence

3 Heating curve

4 Set room temperature influence

5 Low end

□ □ □ ■ GRADIENT

With the „GRADIENT“ parameter, you can set the extent to which a change in the outside temperature causes a rise in the flow temperature. Typical problem: Increase the gradient if the room temperature is too low at low outside temperatures (approx. -10 °C).

□ □ □ ■ LOW END

By changing the „LOW END“ parameter, you cause a parallel offset of the heating curve. Typical applications are explained in the chapter „Troubleshooting“.

□ □ □ ■ ROOM INFLUENCE

If you want to influence the heating curve through the room temperature, install an auxiliary „FES Comfort“ programming unit in your home. As the underfloor heating system has a delayed effect on the room temperature, this can be counteracted via additional heating such as solar irradiation or a fireplace. You must enter a value > 0 for the „ROOM INFLUENCE“ parameter.

Set heating circuit temperature = set heating circuit temperature from heating curve + ((set room temperature - actual room temperature) * room influence * gradient / 10)

OPERATION

Operation

■ FLOW PROPORTION

Flow means the pipework that supplies hot water to the heating system. The return carries the cooled water from the heating system to the heating system. With the „FLOW PROPORTION“ parameter you determine whether your heating system should function as a flow or return temperature-controlled system.

Setting	Control	Flow [%]	Return [%]
0	Return temperature control	0	100
30		30	70
50		50	50
80		80	20
100	Flow temperature control	100	0

You should normally set values below 50 (we recommend 30) for heating circuit 1, to restrict the influence of the flow temperature. Particularly in spring and autumn, the flow temperature is subject to naturally strong fluctuations because of the heat pump being switched on and off. If these strong fluctuations make it necessary, the booster stages would also be started, although the heat pump alone would be capable of covering the current heat demand.

No flow proportion is scanned for heating circuit 2. Always enter 100 here, as the mixer circuit does not have its own return sensor.

■ MIN. SET VALUE / MAX. SET VALUE

With these parameters, you set the minimum and maximum set temperatures for the heating circuit. These values limit the heating curve in the upper and lower regions. Even if the calculated heating curve would go beyond these limits, it is limited to these set values.

■ HEATING CURVE

Under this parameter, you can display the heating curves for both heating circuits.

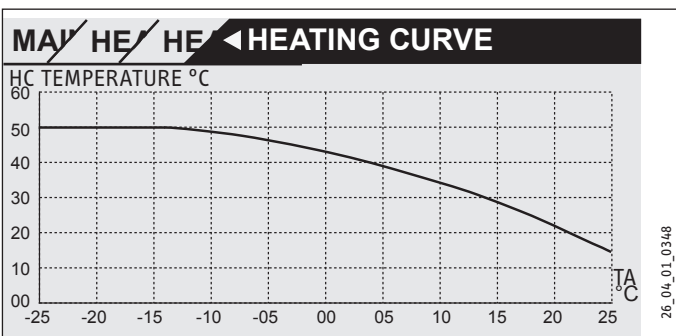

Note that parameter „FLOW PROPORTION“ has an influence on heating curve „HC1“. This means the heating curve is distinctly lower than the flow temperature curve. (see examples 1 and 2).

The heating curve for „HC2“ is a flow temperature curve.

Example 1

Heating curve 55/40, Radiator heating system

Set room temperature	°C	20
Low end	°C	5
Gradient		0.65
Flow proportion	%	30
Design temperature	°C	-15

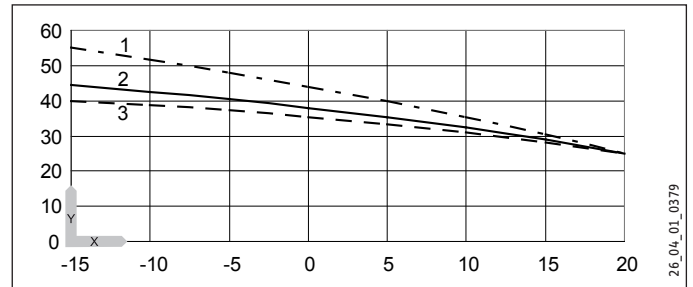

- X Outside temperature [°C]
- Y Heating temperature [°C]
- 1 Flow
- 2 Heating curve
- 3 Return

Example 2

Heating curve 35/28, Underfloor heating

Set room temperature	°C	20
Low end	°C	1
Gradient		0.3
Flow proportion	%	30
Design temperature	°C	-15

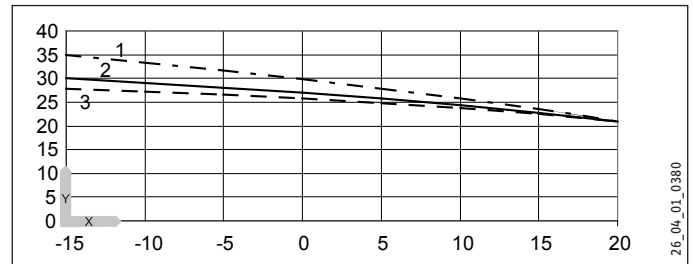

- X Outside temperature [°C]
- Y Heating temperature [°C]
- 1 Flow
- 2 Heating curve
- 3 Return

If you have set the heating curve successfully, set the thermostatic valves to the required temperature.

Note
Never reduce the temperature in the entire building by closing all thermostatic valves. Instead, use the night programs or select the set room temperature with the "HOTTER / COLDER" parameter.

■ STANDARD SETTING

These parameters are reserved for qualified contractors and are described in the installation instructions.

■ DHW

■ DHW TEMPERATURES

- DHW SET DAY
- DHW SET NIGHT
- DHW SET STANDBY
- DHW SET MANUAL
- DHW TEMPERATURE

OPERATION

Operation

Select the set DHW temperatures here. Enter the values for day, setback, standby and manual modes. Subject to operating mode, the temperature in the DHW cylinder is brought to the corresponding set value. The current water temperature in the cylinder is shown under „DHW TEMPERATURE“.

MIXED WATER AMOUNT

For this appliance, this menu displays no parameters other than the actual value „MIXED WATER AMOUNT“. The amount of mixed water indicated does not relate to any second DHW cylinder that may be connected.

STANDARD SETTING

These parameters are reserved for qualified contractors and are described in the installation instructions.

VENTILATION

Here, you can set the parameters for the centralised ventilation of your home.

VENTILATION STAGES

DAY STAGE

NIGHT STAGE

STANDBY STAGE

PARTY STAGE

MANUAL STAGE

VENTILATION TIMES

UNSCHED. VENT TIME STAGE 0

UNSCHED. VENT TIME STAGE 1

UNSCHED. VENT TIME STAGE 2

UNSCHED. VENT TIME STAGE 3

VENTILATION STAGES

	Stage	
Ventilation for humidity protection	0	Necessary ventilation for ensuring that the building structure is protected under normal conditions of use with somewhat reduced moisture loads, e.g. during temporary absence of users and no drying of washing in the residential unit.
Reduced ventilation	1	Ventilation necessary to meet minimum hygiene standards and ensure protection of the building structure (humidity) under normal conditions of use with partially reduced humidity and pollutant loads, e.g. as a result of intermittent user absence.
Standard ventilation	2	Ventilation necessary to meet hygiene standards and ensure protection of the building structure when users are present (standard mode).
Intensive ventilation	3	Ventilation necessary from time to time, with a higher air flow rate to reduce load peaks. For intensive ventilation, it can be assumed that the user will assist (by manually opening windows for a time).

VENTILATION TIMES

Normally, the appliance controls when and for how long to ventilate. However, via the quick access option „VENTILATION STAGES“ you can run ventilation outside the normal schedule.

Under „UNSCHED. VENT TIME STAGE 1“ determine for how many minutes the fan should run, if you set the appliance to stage 1 via parameter „VENTILATION STAGES“. Specify the ventilation times for stages 0, 2 and 3 accordingly.

The selected ventilation stage will not be enabled for 20 seconds.

Quick ventilation with external pushbutton

With an external pushbutton that can be installed on site, you can set ventilation immediately to stage 3. Ventilation runs with stage 3 and will only switch off after the time set in parameter „UNSCHED. VENT TIME STAGE 3“.

Humidity protection ventilation (stage 0)

The control unit includes a humidity protection ventilation function. This is provided to protect against humidity damage, if ventilation is not required. This could be, for example, during prolonged absence due to holidays. For this, in the „VENTILATION / PARAMETER“ menu, the humidity protection parameter must be set to „ON“. The humidity protection ventilation is activated after a pause of 24 hours. Ventilation is inactive prior to the expiry of the 24 hour period.

Ventilation starts if the relative humidity inside the room exceeds a limit whilst ventilation is switched off (stage 0). Ventilation is switched off again if the limit is undershot by more than the selected hysteresis. The limit is dependent on the outside temperature.

► Please consult your qualified contractor.

Fan output correction (stage 1/2/3) subject to humidity

For output stages 1, 2 and 3, the qualified contractor can activate a correction subject to humidity. This is made subject to the relative humidity in the room. At low levels of relative humidity, such as in winter, for example, the air flow rate will be reduced subject to the output reduction parameter. This counteracts excessive drying out. In summer, the humidity-dependent fan output correction can reduce excessive humidity levels in rooms.

► Please consult your qualified contractor.

SERVICE

„RUNTIME FILTER“: This parameter indicates when the last filter reset was carried out.

„RESET FILTER“: This parameter enables you to carry out a filter reset by selecting „ON“.

COOLING

The FES Comfort digital remote control is equipped with a temperature sensor as well as a humidity sensor that is used to monitor the dew point in area heating systems (such as underfloor heating systems, wall area heating systems, chilled ceilings).

Active cooling

If the heating circuit temperature is greater than the set heating circuit temperature, and the „COOLING MODE“ parameter is enabled, the compressor and defrost valve switch on and the hydraulics are controlled externally. For cooling mode to function via area heating systems, cooling thermostats and control valves must be used and connected to the „Cool“ port in the appliance control panel.

OPERATION

Operation

Cooling and DHW heating

Cooling mode is interrupted as soon as a DHW demand is issued, and DHW heating commences.

Cooling and solar

Under parameter „SOLAR“ qualified contractors can use parameter „PRIORITY SOLAR“ to select the priority for cooling operation if a solar thermal system is connected. Possible settings are „Priority solar“, „Priority cooling“ and the time-controlled setting via „Priority cooling time“. This programs the period for cooling. If „Priority solar“ has been selected, cooling will not be enabled for as long as the solar starting conditions are met and the maximum system temperatures have not been reached. With „Priority cooling“, the solar overload function and collector protection are disabled. The solar start conditions are checked as soon as cooling ends.

► Enable cooling mode for the required heating circuits by setting parameter „COOLING MODE“ („OFF“ / „ON“).

ROOM TEMPERATURES HC1

<input type="checkbox"/> <input type="checkbox"/> <input checked="" type="checkbox"/> ROOM TEMPERATURE DAY HC1	
<input type="checkbox"/> <input type="checkbox"/> <input checked="" type="checkbox"/> ROOM TEMP. NIGHT HC1	
<input type="checkbox"/> <input type="checkbox"/> <input checked="" type="checkbox"/> ROOM TEMP. STANDBY HC1	
<input type="checkbox"/> <input type="checkbox"/> <input checked="" type="checkbox"/> ROOM TEMPERATURE HC1	

To allow the appliance to cool, you must set the „COOLING MODE“ parameter to the value „ON“. Refer to your qualified contractor for the required adjustments.

Cooling is enabled when the appliance is in summer mode and the outside temperature exceeds the set room temperature for heating by 3 K for 2 hours. If the room temperature is then higher than the set room temperature for cooling by the amount set in the „HYST. ROOM TEMP.“ parameter, cooling will be prepared. The display shows a snowflake. The circulation pump starts, the three-way valve changes over to the heating circuit and the „cooling“ output is activated in order to, for example, open the thermostatic valves in the rooms to be cooled.

By selecting a set room temperature you can influence when the appliance starts its cooling operation.

ROOM TEMPERATURES HC2

See chapter „ROOM TEMPERATURES HC1“.

COOLING MODE HC1

<input type="checkbox"/> <input type="checkbox"/> <input checked="" type="checkbox"/> COOLING MODE HC1	OFF ON	
<input type="checkbox"/> <input type="checkbox"/> <input checked="" type="checkbox"/> COOLING SYSTEM HC1	AREA COOLING FAN COOLING	Code-protected
<input type="checkbox"/> <input type="checkbox"/> <input checked="" type="checkbox"/> HC TEMP. COOLING HC1		Code-protected
<input type="checkbox"/> <input type="checkbox"/> <input checked="" type="checkbox"/> HYST. ROOM TEMP. HC1		Code-protected

COOLING MODE HC2

See chapter „COOLING MODE HC1“.

SOLAR THERMAL

<input type="checkbox"/> <input checked="" type="checkbox"/> SOLAR ACTIVATION	OFF ON
<input type="checkbox"/> <input type="checkbox"/> <input checked="" type="checkbox"/> TEMP. DIFFERENTIAL	

<input type="checkbox"/> <input type="checkbox"/> <input checked="" type="checkbox"/> DHW COMPRESSOR DELAY	
<input type="checkbox"/> <input type="checkbox"/> <input checked="" type="checkbox"/> DHW SOLAR TEMP.	

If you have connected a solar thermal system, you will find all the parameters here which have to be specified for solar mode. In solar mode, the appliance is backed up by the solar heat exchanger for DHW heating and central heating.

SOLAR ACTIVATION

If you want to enable solar mode, set the value in parameter „SOLAR ACTIVATION“ to 1.

TEMP. DIFFERENTIAL

With the aid of this parameter, also known as solar differential temperature, you define a temperature that is used as the threshold for starting and stopping the solar circuit pump.

The solar circuit pump starts if the collector temperature is higher than the return temperature by the „TEMP. DIFFERENTIAL“ + „SOLAR HYSTERESIS“. The solar circuit pump stops if the collector temperature is only „TEMP. DIFFERENTIAL“ - „SOLAR HYSTERESIS“ above the return temperature. The parameter „SOLAR HYSTERESIS“ is set by the qualified contractor.

Ensure that the stop point is not below the return temperature. That can be the case if the hysteresis has been set above the temperature differential. The greater the value of the solar differential temperature, the later the solar circuit pump starts when the sun comes out. At the same time, the risk of heat loss from the cylinder is reduced. If heat were lost from the cylinder, the thermal energy would flow in the opposite direction, i.e. water that had already been heated would be cooled down because insolation was still too low.

DHW COMPRESSOR DELAY

When the solar circuit pump runs, the compressor is blocked for the period defined here. DHW is only heated with solar energy during this time.

DHW SOLAR TEMP.

If the DHW cylinder has been heated up, the set flow temperature has been reached and the collector temperature remains high, the DHW cylinder can be heated up to a higher temperature to store solar energy.

Set the temperature to which the DHW cylinder should be heated here.



WARNING Burns
Parameter "DHW SOLAR TEMP." should only be set higher than 60 °C if suitable measures have been taken to provide protection against scalding. There is a risk of scalding at outlet temperatures in excess of 43 °C.

If you want to use the solar function, your qualified contractor should set the following values:

MINIMUM CYCLES		1
MAXIMUM CYCLES		≥50
OUTSIDE TEMP MAX CYC	°C	0
OUTSIDE TEMP MIN CYC	°C	25

OPERATION

Operation

■ SCREED DRYING PROG.

The dry heating (screed drying) program is not necessary for daily requirements. The explanation can be found in the installation instructions for qualified contractors.

■ COMMISSIONING

■ PROGRAMMING UNIT

■ CONTROL UNIT SOFTWARE

The programming unit's software version is displayed here.

■ CONTRAST

With the „CONTRAST“ parameter, you can set the contrast between the characters shown on the display and the display background.

■ BRIGHTNESS

■ LANGUAGE

Here you can select the language in which the display texts are shown.

■ ROOM TEMP CORRECTION

If the room temperature captured by the programming unit does not correspond with the actual room temperature, for example if the sensor is mounted on a cold external wall, you can make a correction at the appliance. In the parameter „ROOM TEMP CORRECTION“, enter the difference between the actual room temperature and the room temperature displayed on the programming unit.

Example:

Actual temperature	°C	19
Displayed temperature	°C	21
New parameter value		-2

■ REL HUMIDITY CORRECTION

If the relative humidity in the room as measured on the programming unit does not correspond to the real relative humidity in the room, you can make a correction on the appliance. If the value displayed by the programming unit is too low, increase the value set under parameter „REL HUMIDITY CORRECTION“.

■ CONTROLLER

■ SOFTWARE VERSION

„SOFTWARE VERSION“ shows which software version is installed on the control PCB. The software version indicates the appliance type.

■ SOFTWARE ID

„SOFTWARE ID“ shows the consecutive number of the software.

■ TIME / DATE

■ TIME / DATE

In the „TIME / DATE“ menu, enter the current time and date, so the appliance can start the time programs you enter at the correct time. Position the selection indicator over the position „YEAR“ and confirm with „OK“. Set the current year and confirm with „OK“. Set the month accordingly. To help you set the „Day“, a calendar page appears. Move the highlighter to the required day. The new value is saved when you confirm with „OK“.

■ SUMMERTIME MANUAL

Under the „SUMMERTIME MANUAL“ menu item, you can set the period for summertime.

■ SUMMERTIME AUTOMATIC

Instead of entering the time period for summer mode manually, you can select the summertime specified at the factory. For this, set the „SUMMERTIME AUTOMATIC“ menu item to „ON“.

■ CONTRACTOR

The parameters in the „CONTRACTOR“ menu have a great influence on the appliance control properties, and are therefore protected with a password to prevent incorrect settings. As an appliance user, you can see these parameters, but if you jump to the next menu level, you meet the code check.

■ FAULT SEARCH

If the appliance registers a fault, this is clearly displayed with the message shown below.

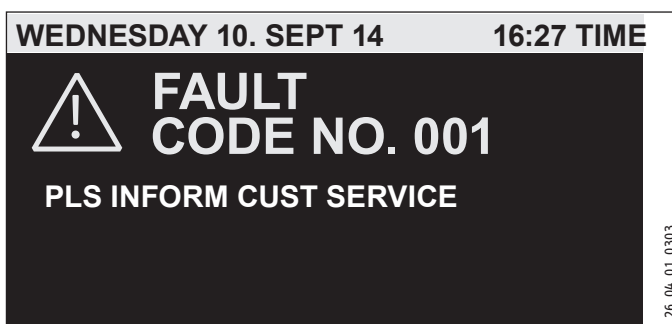

If more than one fault occurs, the most recent fault is always shown. Please inform your qualified contractor. To see the usual default display, first enable the programming unit by pressing „MENU“ for 5 seconds. The fault message is then extended with a note requesting that you acknowledge the fault by pressing OK for five seconds.

■ FAULT LIST

The fault list contains the ten most recent fault messages. The display, however, can show only six fault messages at a time. Scroll with the scroll wheel to access the other entries in the fault list.

■ PROCESS VALUES

These values are used for analysis in the event of a fault.

OPERATION

Cleaning, care and maintenance

PROCESS STATUS

These values are used for analysis in the event of a fault.

ANALYSIS

In the „ANALYSIS“ submenu actual values are displayed that may be useful to the service department when troubleshooting.

INVERTER

These values are used for analysis in the event of a fault.

5. Cleaning, care and maintenance



Note

Keep the air intake and discharge apertures on the exterior wall free from snow and leaves.

- ▶ Check the supply air and extract air filters regularly for contamination.

5.1 Replacing supply air and extract air filters



Note

This chapter is only relevant for appliances with ventilation function.

- ▶ Hold down „MENU“ button for three seconds.
- ▶ If you have already navigated through the menu tree, pressing MENU will return you to the default display. If necessary you may have to press menu several times.
- ▶ Use the scroll wheel to navigate to the „VENTILATION STAGES“ entry.
- ▶ Press „OK“.
- ▶ Press „OK“ again to adjust the „Unscheduled vent.“ parameter.
- ▶ Set the „UNSCHEDULED VENT.“ parameter to 0.
- ▶ Confirm with OK.
- ▶ Set the „UNCHED. VENT TIME STAGE 0“ parameter to a suitable value, e.g. 30 minutes.

A door lock is located above the door.

- ▶ Push the door lock at the front upwards.
- ▶ Pull the door lock backwards and then upwards to unhook the door lock.

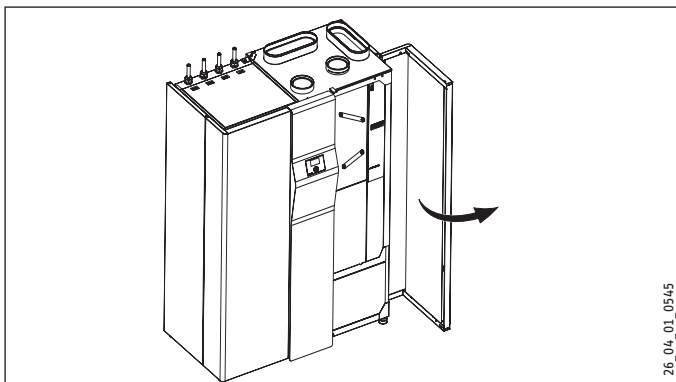

- ▶ Open the door carefully.

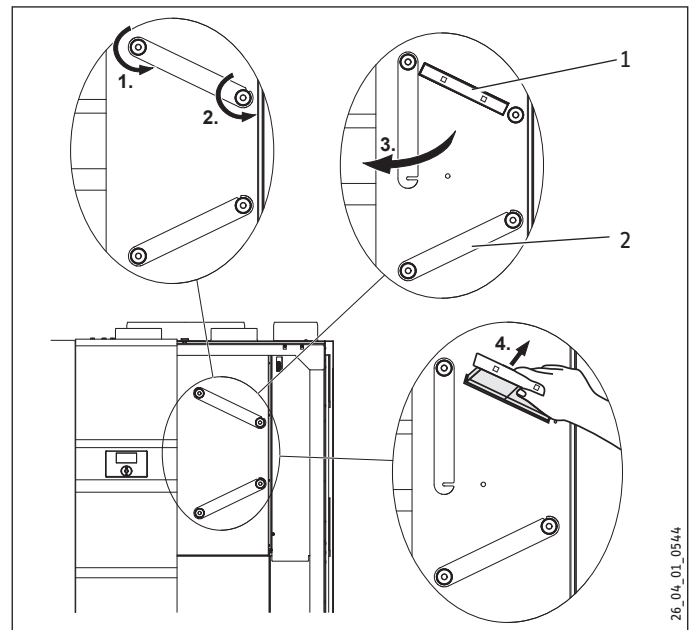

1 Extract air filter

2 Supply air filter

- ▶ Undo the r.h. knurled nut by turning it anti-clockwise.
- ▶ Loosen the left knurled nut by turning it anti-clockwise so that you can carefully pivot the filter cover aside.
- ▶ Pull out the filter cassette.



Note

Ensure that you do not interchange the extract air and supply air filters when reinserting them into the appliance. The filter cassette of the extract air filter (upper filter) features two grip holes at the front.



Note

Ensure that the direction of air flow through the filter is correct.

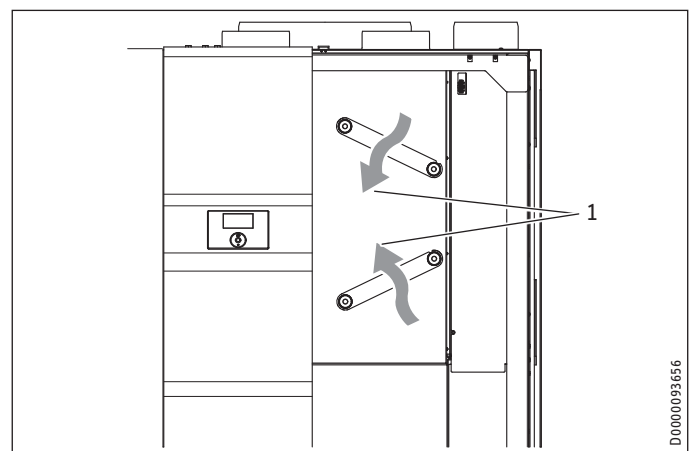

1 Direction of flow

ISO Coarse $\geq 60\%$ (G4)

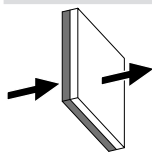

The more coarsely porous, blue side is the air intake side of the filter.

ePM₁₀ $\geq 50\%$ (M5) / ePM₁ $\geq 50\%$ (F7)

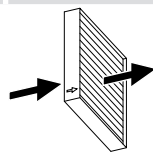

The direction of flow is indicated by an arrow on the side of the filter.

- ▶ Replace the filter.
- ▶ Push the new filter cassette into the appliance.
- ▶ Rotate the filter cover back into its original position and then tighten the r.h. knurled nut clockwise.
- ▶ Tighten the l.h. knurled nut.
- ▶ At the programming unit, activate the „RESET FILTER“ parameter („SETTINGS / VENTILATION / SERVICE“).



WARNING Injury

All other work on the appliance must only be carried out by qualified contractors.



Note

Have the cross-counter-current heat exchanger, outdoor air filter, evaporator and fans checked and (if required) cleaned once a year by a qualified contractor.

5.2 Replacing the outdoor air filter

The outdoor air filter is fitted downstream of the cross-counter-current heat exchanger. The outdoor air filter must be replaced by a qualified contractor.

5.3 Cleaning the extract and supply air vent filters

- ▶ If installed, clean the extract air vent filters through which air is extracted from the rooms.
- ▶ If installed, clean the supply air vent filters through which air is supplied to the rooms.
- ▶ Clean the filter box (if present) attached to the outdoor air connector on the rear of the appliance.

6. Troubleshooting

6.1 Filter symbols appear

The appliance is equipped with an automatic filter contamination detector. The constant flow rate control of the fans results in an increase in fan speed when the filters become contaminated. This increase in speed is evaluated to display a filter change requirement.

When the filters are contaminated, the following symbols are displayed.



Filter change, top:

The extract air filter is contaminated. Please change the extract air filter.



Filter change, bottom:

The supply air filter is contaminated. Please change the supply air filter.



Filter change, top and bottom:

Extract air and supply air filters are contaminated or their filter change intervals have expired. Please change the extract air and supply air filters.

The filter symbol appears automatically after three months.

6.2 No hot water

Should you fail to obtain hot water, you can take the following steps to remedy the situation yourself:

- If the appliance has no power: Check the fuse/circuit breaker in your fuse box. If it has blown/tripped, replace/reset the fuse/ MCB. Notify your qualified contractor if the fuse/ MCB blows/trips again.
- If the appliance has power: Check whether the air intake/ discharge is blocked. Check whether a fault code is being displayed, and if necessary, notify your qualified contractor. Check whether the control unit is set correctly.

6.3 The safety valve of the cold water supply line is dripping

This may occur during the heat-up phase and is completely normal.

6.4 The fault symbol appears



Note

If this symbol appears, it means a fault has occurred. Notify your qualified contractor or call customer service.

6.5 The appliance leaks water

If water escapes from the appliance, shut it down immediately and notify your qualified contractor.

6.6 Condensate on the outside of the appliance or on the air hoses

In the drying out phase or when relative humidity is high (>60%), it is normal for condensate to appear on the surface of the appliance and on the thermally insulated air hoses. This should stop when the house has dried out thoroughly which, subject to the design, can take up to 2 years. If the room is used to dry washing however, condensate can still form.

- ▶ Check whether the air hoses are fitted correctly, and that no cold air escapes.

6.7 Noise is emitted

Since the appliance moves very large volumes of air, it cannot work silently.

However, there should not be any disturbing noises in the living rooms and bedrooms. To achieve this, ensure that

- the appliance has been installed correctly.
- the installation room has a door that closes tightly.
- adequately sized silencers are integrated directly on the appliance in the supply air and extract air ducts.
- additional silencers are installed between bedrooms, nurseries and living rooms.

- the air volumes have been adjusted and checked according to the system design.

If you notice dragging noises when the fan or heat pump are in operation, take the appliance out of use immediately and notify your qualified contractor.

If dragging noises occur during heat pump operation, the exhaust air fan may be the cause. During shipping, the fan may slightly move in relation to the air nozzle. This may result in dragging noises. If necessary, the exhaust air fan should be aligned as part of the commissioning work.

Contamination of the outdoor air filter can lead to higher noise emissions. The outdoor air filter is fitted downstream of the cross-counter-current heat exchanger. The outdoor air filter must be replaced by a qualified contractor.

6.8 The required flow temperatures are not reached, particularly during drying out

When drying screed, output levels will be required that are far above those necessary for standard heating operation. It can therefore take a relatively long time before, for example, the low end temperature is reached. However, the correct temperature curve for drying out is ensured because the next stage in every case is not started until the default temperature for the current step has been reached. In case of all other faults, please always notify your qualified contractor.

6.9 The accommodation is always too cold

Increase the low end temperature of the heating curve. Raise the temperature by the number of degrees you require to obtain a comfortable temperature.

6.10 The accommodation is always too hot

Reduce the low end temperature of the heating curve by the number of degrees the room temperature exceeds a comfortable temperature.

6.11 The accommodation is too cold in winter

If the temperature of your home in spring and autumn is OK, but the rooms do not become warm enough when the outside temperature drops sharply (-10 °C), increase the gradient of the heating curve. This means it will become slightly warmer in spring and autumn. You should therefore slightly lower the low end temperature.

Another reason might be the dual mode point. Increasing the dual mode point, however, can lead to high energy consumption.

If sound-reduced night mode is activated, in rare cases there may not be enough heating output available at low outside temperatures. Change the value of the „DUAL MODE POINT“ parameter.

6.12 The accommodation is too hot in winter

If your heating system produces too much heat when temperatures drop sharply, reduce the gradient of the heating curve. This means your home will become slightly colder in spring and autumn. You should therefore slightly raise the low end temperature.

6.13 The accommodation is too cold in spring and autumn

One possible cause may be that summer mode is enabled and that central heating is off, as a result. Switch the appliance to manual mode or ask your qualified contractor to change the standard settings.

If the room temperature in spring and autumn (10 °C) is too low, reduce the gradient and increase the low end temperature.

6.14 The accommodation is too hot in spring and autumn

- ▶ Increase the heating curve gradient slightly and reduce its low end slightly.

6.15 The accommodation is too hot in summer

Stop summer mode and activate passive cooling, if required.

6.16 Air quality is too poor

- ▶ Select a higher fan stage.

6.17 The air in winter is too dry

- ▶ Select fan stage 1.
- ▶ Activate the humidity correction.

When going away, switch the appliance to reduced ventilation. You can set a fan program for this. Here you set the time during which the appliance runs in day mode. For the rest of the time, the appliance runs at the fan stage that you set in the „NIGHT STAGE“ parameter.

If you cannot remedy the fault, notify your qualified contractor. To facilitate and speed up your request, provide the number from the type plate (000000-0000-000000).

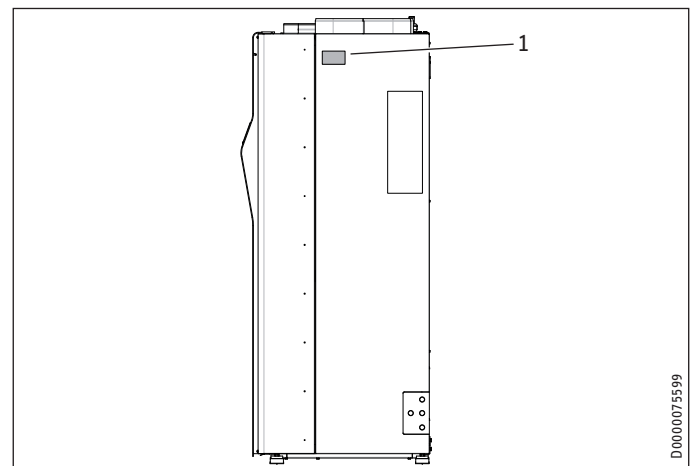

1 Type plate

7. Menu structure

**Note**

Some menu items are protected by a code and can only be accessed and adjusted by a qualified contractor.

**Note**

Subject to appliance type, not all appliance parameters and values are displayed in the different menus.

Menu item/parameter	Unit	Description
■ INFO		
□■ ROOM TEMPERATURE		
□□■ ROOM TEMPERATURE HC1	°C	If an external programming unit is connected and assigned to the heating circuit, the temperature measured in the programming unit is displayed. If the heating circuit has no programming unit assigned, the actual set room temperature is displayed as a substitute value.
□□■ SET ROOM TEMPERATURE HC1	°C	
□□■ RELATIVE HUMIDITY HC1	%	If an external programming unit is connected and assigned to the heating circuit, the humidity measured in the programming unit is displayed. If the heating circuit has no programming unit assigned, 0 % is displayed.
□□■ ROOM TEMPERATURE HC2	°C	If an external programming unit is connected and assigned to the heating circuit, the temperature measured in the programming unit is displayed. If the heating circuit has no programming unit assigned, the actual set room temperature is displayed as a substitute value.
□□■ SET ROOM TEMPERATURE HC2	°C	
□□■ RELATIVE HUMIDITY HC2	%	If an external programming unit is connected and assigned to the heating circuit, the humidity measured in the programming unit is displayed. If the heating circuit has no programming unit assigned, 0 % is displayed.
□■ HEATING		
□□■ OUTSIDE TEMPERATURE		
□□■ ACTUAL VALUE HC1	°C	Heating circuit temperature, calculated from the flow and return temperatures, weighted with the value set under "FLOW PROPORTION". Whilst DHW is being heated, this parameter indicates the temperature with which the DHW cylinder is being heated.
□□■ SET VALUE HC1	°C	Default temperature for the heating circuit
□□■ ACTUAL VALUE HC2	°C	
□□■ SET VALUE HC2	°C	
□□■ FLOW TEMPERATURE	°C	The flow is the heating pipework between heat pump and heat consumer (radiator or indirect coil inside the DHW cylinder). Here you can see the temperature of the water in this pipe section.
□□■ RETURN TEMPERATURE	°C	The return is the heating pipework between heat consumer and the heat pump. Here you can see the temperature of the water in this pipe section.
□□■ PRESSURE HTG CIRC	bar	
□□■ FLOW RATE	l/min	
□■ DHW		
□□■ DHW TEMPERATURE	°C	Shows the current cylinder water temperature
□□■ DHW 2 ACT. TEMP.	°C	If the „2ND DHW CYLINDER“ parameter is set to „ON“, the temperature in the second DHW cylinder is shown here.
□□■ DHW SET TEMPERATURE	°C	
□□■ CYLINDER TOP TEMPERATURE	°C	
□□■ MIXED WATER AMOUNT	l	
□■ VENTILATION		
□□■ SUPPLY AIR ACTUAL	Hz	Indicates the current supply air fan speed.
□□■ SUPPLY AIR SET	m ³ /h	This value indicates the percentage of maximum control voltage with which the supply air fan operates. Supply air is the heated outdoor air that is blown into the ventilation area (living room, bedroom, nursery).
□□■ EXTRACT AIR ACTUAL	Hz	Current speed of the extract air fan
□□■ EXTRACT AIR SET	m ³ /h	This value indicates the percentage of maximum control voltage with which the extract air fan operates. Extract air is the stale air that is extracted from the extract air area (bathroom, kitchen, WC).
□□■ EXTRACT AIR HUMIDITY	%	
□□■ EXTRACT AIR TEMP.	°C	
□□■ EXTRACT AIR DEW POINT	°C	
□□■ DIFFERENTIAL PRESSURE ACTUAL	Pa	If the „FAN CONTROL“ parameter is set to „DIFFERENTIAL PRESSURE“, the differential pressure between the extract air and the atmospheric pressure in the installation room is shown here.
□■ COOLING		
□□■ DEW POINT TEMP. HC1	°C	
□□■ DEW POINT TEMP. HC2	°C	
□■ SOLAR THERMAL		

OPERATION

Menu structure

Menu item/parameter	Unit	Description
<input type="checkbox"/> <input type="checkbox"/> <input type="checkbox"/> COLLECTOR TEMP.	°C	Temperature of the solar collector
<input type="checkbox"/> <input type="checkbox"/> HEAT GENERATOR		
<input type="checkbox"/> <input type="checkbox"/> HEATING STAGE		
<input type="checkbox"/> <input type="checkbox"/> HEAT PUMP		
<input type="checkbox"/> <input type="checkbox"/> <input type="checkbox"/> HOT GAS TEMPERATURE	°C	This value specifies the temperature of the gaseous refrigerant at the condenser inlet.
<input type="checkbox"/> <input type="checkbox"/> <input type="checkbox"/> HIGH PRESSURE	bar	
<input type="checkbox"/> <input type="checkbox"/> <input type="checkbox"/> LOW PRESSURE	bar	
<input type="checkbox"/> <input type="checkbox"/> <input type="checkbox"/> EVAPORATOR TEMP.	°C	In the evaporator, the refrigerant is evaporated at low pressure. As this happens, heat is extracted from the air flow.
<input type="checkbox"/> <input type="checkbox"/> <input type="checkbox"/> CONDENSER TEMP.	°C	In the condenser, the refrigerant is liquefied at high pressure. This releases heat which is transferred to the heating medium.
<input type="checkbox"/> <input type="checkbox"/> <input type="checkbox"/> OIL SUMP TEMPERATURE	°C	
<input type="checkbox"/> <input type="checkbox"/> <input type="checkbox"/> EXHAUST AIR ACTUAL	Hz	Current speed of the exhaust air fan
<input type="checkbox"/> <input type="checkbox"/> <input type="checkbox"/> EXHAUST AIR SET		Set flow rate of the heat pump fan
<input type="checkbox"/> <input type="checkbox"/> <input type="checkbox"/> DIFF. PRESSURE EVAP.	Pa	
<input type="checkbox"/> <input type="checkbox"/> <input type="checkbox"/> COMPRESSOR STARTS		
<input type="checkbox"/> <input type="checkbox"/> <input type="checkbox"/> AMOUNT OF HEAT		
<input type="checkbox"/> <input type="checkbox"/> <input type="checkbox"/> HEAT METER HTG DAY	kWh	Amount of heat that was transferred by the heat pump to the heating circuit on this day.
<input type="checkbox"/> <input type="checkbox"/> <input type="checkbox"/> HEAT METER HTG TTL	MWh	Amount of heat that has been transferred by the heat pump to the heating circuit since the appliance was commissioned.
<input type="checkbox"/> <input type="checkbox"/> <input type="checkbox"/> HEAT METER DHW DAY	kWh	Amount of heat that was transferred by the heat pump to the DHW cylinder on this day.
<input type="checkbox"/> <input type="checkbox"/> <input type="checkbox"/> HEAT METER DHW TTL	MWh	Amount of heat that has been transferred by the heat pump to the DHW cylinder since the appliance was commissioned.
<input type="checkbox"/> <input type="checkbox"/> <input type="checkbox"/> HEAT M BOOST HTG TTL	MWh	Amount of heat that has been transferred by the electric emergency/booster heater to the heating circuit since the appliance was commissioned
<input type="checkbox"/> <input type="checkbox"/> <input type="checkbox"/> HEAT M BOOST DHW TTL	MWh	Amount of heat that has been transferred by the electric emergency/booster heater to the DHW cylinder since the appliance was commissioned
<input type="checkbox"/> <input type="checkbox"/> <input type="checkbox"/> HEAT M RECOVERY DAY	kWh	Amount of heat that was recovered from the ventilation system on this day.
<input type="checkbox"/> <input type="checkbox"/> <input type="checkbox"/> HEAT M RECOVERY TTL	MWh	Amount of heat that has been recovered from the ventilation system since the appliance was commissioned.
<input type="checkbox"/> <input type="checkbox"/> <input type="checkbox"/> HM SOLAR HTG DAY	kWh	Amount of heat that was transferred by the solar thermal system to the heating circuit on this day.
<input type="checkbox"/> <input type="checkbox"/> <input type="checkbox"/> HM SOLAR HTG TOTAL	MWh	Amount of heat that has been transferred by the solar thermal system to the heating circuit since the appliance was commissioned.
<input type="checkbox"/> <input type="checkbox"/> <input type="checkbox"/> HM SOLAR DHW DAY	kWh	Amount of heat that was transferred by the solar thermal system to the DHW cylinder on this day.
<input type="checkbox"/> <input type="checkbox"/> <input type="checkbox"/> HM SOLAR DHW TOTAL	MWh	Amount of heat that has been transferred by the solar thermal system to the DHW cylinder since the appliance was commissioned.
<input type="checkbox"/> <input type="checkbox"/> <input type="checkbox"/> HM COOLING TOTAL	MWh	Amount of heat absorbed by the appliance via its evaporator from the rooms.
<input type="checkbox"/> <input type="checkbox"/> <input type="checkbox"/> RUNTIMES		Here, the runtime of some appliance components since appliance commissioning is shown.
<input type="checkbox"/> <input type="checkbox"/> <input type="checkbox"/> COMPRESSOR HEATING	h	
<input type="checkbox"/> <input type="checkbox"/> <input type="checkbox"/> COMPRESSOR COOLING	h	
<input type="checkbox"/> <input type="checkbox"/> <input type="checkbox"/> COMPRESSOR DHW	h	
<input type="checkbox"/> <input type="checkbox"/> <input type="checkbox"/> ELEC BOOSTER HEATING	h	
<input type="checkbox"/> <input type="checkbox"/> <input type="checkbox"/> ELEC BOOSTER DHW	h	
<input type="checkbox"/> <input type="checkbox"/> <input type="checkbox"/> POWER CONSUMPTION		
<input type="checkbox"/> <input type="checkbox"/> <input type="checkbox"/> PWR CON HTG DAY	kWh	Power drawn by the compressor on this day for supplying the heating circuit.
<input type="checkbox"/> <input type="checkbox"/> <input type="checkbox"/> PWR CON HTG TTL	MWh	Power drawn by the compressor since commissioning for supplying the heating circuit
<input type="checkbox"/> <input type="checkbox"/> <input type="checkbox"/> PWR CON DHW DAY	kWh	Power drawn by the compressor on this day for supplying the DHW cylinder
<input type="checkbox"/> <input type="checkbox"/> <input type="checkbox"/> PWR CON DHW TTL	MWh	Power drawn by the compressor since commissioning for supplying the DHW cylinder
<input checked="" type="checkbox"/> DIAGNOSIS		
<input type="checkbox"/> <input type="checkbox"/> <input type="checkbox"/> SYSTEM STATUS		
<input type="checkbox"/> <input type="checkbox"/> <input type="checkbox"/> POWER-OFF		
<input type="checkbox"/> <input type="checkbox"/> <input type="checkbox"/> STOVE / FIREPLACE		
<input type="checkbox"/> <input type="checkbox"/> <input type="checkbox"/> AIR HEAT EXCH. DEFR.		
<input type="checkbox"/> <input type="checkbox"/> <input type="checkbox"/> EVAPORATOR DEFROST		
<input type="checkbox"/> <input type="checkbox"/> <input type="checkbox"/> SILENTMODE		Status of sound-reduced night mode (1 = active, 0 = inactive)
<input type="checkbox"/> <input type="checkbox"/> <input type="checkbox"/> SOLAR		Status of the solar circuit pump (1 = active, 0 = inactive)
<input type="checkbox"/> <input type="checkbox"/> <input type="checkbox"/> SUMMER MODE		Here, the display shows whether the appliance is in summer mode (1 = summer mode).
<input type="checkbox"/> <input type="checkbox"/> <input type="checkbox"/> FAULT LIST		

OPERATION

Menu structure

Menu item/parameter	Options	Unit	Min.	Max.	Standard	System value
PROGRAMS						
<input type="checkbox"/> HEATING PROGRAM						
<input type="checkbox"/> HEATING CIRCUIT 1						
<input type="checkbox"/> MONDAY	Time period 1 Time period 2 Time period 3					
<input type="checkbox"/> TUESDAY	Time period 1 Time period 2 Time period 3					
<input type="checkbox"/> WEDNESDAY	Time period 1 Time period 2 Time period 3					
<input type="checkbox"/> THURSDAY	Time period 1 Time period 2 Time period 3					
<input type="checkbox"/> FRIDAY	Time period 1 Time period 2 Time period 3					
<input type="checkbox"/> SATURDAY	Time period 1 Time period 2 Time period 3					
<input type="checkbox"/> SUNDAY	Time period 1 Time period 2 Time period 3					
<input type="checkbox"/> MON - FRI	Time period 1 Time period 2 Time period 3					
<input type="checkbox"/> SAT - SUN	Time period 1 Time period 2 Time period 3					
<input type="checkbox"/> MON - SUN	Time period 1 Time period 2 Time period 3					
<input type="checkbox"/> HEATING CIRCUIT 2	See HEATING CIRCUIT 1					
<input type="checkbox"/> DHW PROGRAM	See HEATING CIRCUIT 1					
<input type="checkbox"/> FAN PROGRAM	See HEATING CIRCUIT 1					
<input type="checkbox"/> HOLIDAY PROGRAM						
<input type="checkbox"/> HOLS BEGINNING						
<input type="checkbox"/> DAY			1	31	1	
<input type="checkbox"/> MONTH			1	12	1	
<input type="checkbox"/> YEAR			0	99	11	
<input type="checkbox"/> HOUR			0	23		
<input type="checkbox"/> MINUTE			0	59		
<input type="checkbox"/> HOLIDAYS ENDING						
<input type="checkbox"/> DAY			1	31	1	
<input type="checkbox"/> MONTH			1	12	1	
<input type="checkbox"/> YEAR			0	99	11	
<input type="checkbox"/> HOUR			0	23	0	
<input type="checkbox"/> MINUTE			0	59		
<input type="checkbox"/> PARTY PROGRAM						
<input type="checkbox"/> START			00:00	23:45		
<input type="checkbox"/> END			00:00	23:45		
<input type="checkbox"/> STANDARD SETTING						
<input type="checkbox"/> MAX. ADVANCE		min	0	300	0	
SETTINGS						
<input type="checkbox"/> HEATING						
<input type="checkbox"/> ROOM TEMPERATURES HC1						
<input type="checkbox"/> ROOM TEMPERATURE DAY HC1		°C	10	30	21	
<input type="checkbox"/> ROOM TEMP. NIGHT HC1		°C	10	30	21	
<input type="checkbox"/> ROOM TEMP. STANDBY HC1		°C	10	30	10	
<input type="checkbox"/> MANUAL SET HC1		°C	10	65	35	
<input type="checkbox"/> ROOM TEMPERATURE HC1		°C				
<input type="checkbox"/> ROOM TEMPERATURES HC2						
<input type="checkbox"/> ROOM TEMPERATURE DAY HC2		°C	10	30	21	
<input type="checkbox"/> ROOM TEMP. NIGHT HC2		°C	10	30	21	
<input type="checkbox"/> ROOM TEMP. STANDBY HC2		°C	10	30	10	
<input type="checkbox"/> MANUAL SET HC2		°C	10	65	35	
<input type="checkbox"/> ROOM TEMPERATURE HC2		°C				
<input type="checkbox"/> HEATING CURVE HC1						
<input type="checkbox"/> GRADIENT HC1			0	5	0.3	
<input type="checkbox"/> LOW END HC1		°C	0	20	3	
<input type="checkbox"/> ROOM INFLUENCE HC1			0	100	0	
<input type="checkbox"/> FLOW PROPORTION HC1			0	100	30	
<input type="checkbox"/> MAX. SET VALUE HC1		°C	10	65	55	
<input type="checkbox"/> MIN. SET VALUE HC1		°C	0	40	10	
<input type="checkbox"/> HEATING CURVE HC1						
<input type="checkbox"/> HEATING CURVE HC2						
<input type="checkbox"/> GRADIENT HC2			0	5	0.3	
<input type="checkbox"/> LOW END HC2		°C	0	20	3	
<input type="checkbox"/> ROOM INFLUENCE HC2			0	100	0	
<input type="checkbox"/> MAX. SET VALUE HC2		°C	10	65	55	
<input type="checkbox"/> MIN. SET VALUE HC2		°C	0	40	10	
<input type="checkbox"/> HEATING CURVE HC2						
<input type="checkbox"/> STANDARD SETTING						
<input type="checkbox"/> PROP. COMP.		%/K	0	10	2	

OPERATION

Menu structure

Menu item/parameter	Options	Unit	Min.	Max.	Standard	System value
<input type="checkbox"/> <input type="checkbox"/> <input type="checkbox"/> <input type="checkbox"/> I COMPONENT INV		Kmin	0	500	500	
<input type="checkbox"/> <input type="checkbox"/> <input type="checkbox"/> <input type="checkbox"/> MAX BOOSTER STG HTG			0	3	3	
<input type="checkbox"/> <input type="checkbox"/> <input type="checkbox"/> <input type="checkbox"/> MAX FLOW TEMP HTG.		°C	10	75	60	
<input type="checkbox"/> <input type="checkbox"/> <input type="checkbox"/> <input type="checkbox"/> SUMMER MODE		°C	10	25	17	
<input type="checkbox"/> <input type="checkbox"/> <input type="checkbox"/> <input type="checkbox"/> HYST. SUMMER MODE		K	1	7	4	
<input type="checkbox"/> <input type="checkbox"/> <input type="checkbox"/> <input type="checkbox"/> OUTSIDE T ADJUSTMENT		h	0	24	1	
<input type="checkbox"/> <input type="checkbox"/> <input type="checkbox"/> <input type="checkbox"/> DUAL MODE POINT		°C	-20	10	-10	
<input type="checkbox"/> <input type="checkbox"/> <input type="checkbox"/> <input type="checkbox"/> BOOSTER TIMEOUT		min	0	60	20	
<input type="checkbox"/> <input type="checkbox"/> <input type="checkbox"/> <input type="checkbox"/> OUTSIDE T CORRECTION		°C	-20	30	0	
<input type="checkbox"/> <input type="checkbox"/> <input type="checkbox"/> <input type="checkbox"/> SUPPR TEMP MEAS		s	0	120	60	
<input type="checkbox"/> <input type="checkbox"/> <input type="checkbox"/> <input type="checkbox"/> DESIGN TEMPERATURE		°C	-25	5	-20	
<input type="checkbox"/> <input type="checkbox"/> <input type="checkbox"/> <input type="checkbox"/> HEATING SYS OUTPUT SIZING		%	40	100	100	
<input type="checkbox"/> <input type="checkbox"/> DHW						
<input type="checkbox"/> <input type="checkbox"/> <input type="checkbox"/> DHW TEMPERATURES						
<input type="checkbox"/> <input type="checkbox"/> <input type="checkbox"/> <input type="checkbox"/> DHW SET DAY		°C	10	65	45	
<input type="checkbox"/> <input type="checkbox"/> <input type="checkbox"/> <input type="checkbox"/> DHW SET NIGHT		°C	10	65	45	
<input type="checkbox"/> <input type="checkbox"/> <input type="checkbox"/> <input type="checkbox"/> DHW SET STANDBY		°C	10	65	10	
<input type="checkbox"/> <input type="checkbox"/> <input type="checkbox"/> <input type="checkbox"/> DHW SET MANUAL		°C	10	65	45	
<input type="checkbox"/> <input type="checkbox"/> <input type="checkbox"/> <input type="checkbox"/> DHW TEMPERATURE		°C	-	-	-	
<input type="checkbox"/> <input type="checkbox"/> <input type="checkbox"/> MIXED WATER AMOUNT						
<input type="checkbox"/> <input type="checkbox"/> <input type="checkbox"/> <input type="checkbox"/> MWM SET DAY		l	50	288	200	No function
<input type="checkbox"/> <input type="checkbox"/> <input type="checkbox"/> <input type="checkbox"/> MWM SET NIGHT		l	50	288	150	No function
<input type="checkbox"/> <input type="checkbox"/> <input type="checkbox"/> <input type="checkbox"/> MWM SET STANDBY		l	50	288	50	No function
<input type="checkbox"/> <input type="checkbox"/> <input type="checkbox"/> <input type="checkbox"/> MWM SET MANUAL		l	150	288	150	No function
<input type="checkbox"/> <input type="checkbox"/> <input type="checkbox"/> <input type="checkbox"/> MIXED WATER AMOUNT		l				
<input type="checkbox"/> <input type="checkbox"/> <input type="checkbox"/> STANDARD SETTING						
<input type="checkbox"/> <input type="checkbox"/> <input type="checkbox"/> <input type="checkbox"/> HYSTERESIS		K	2	10	2	
<input type="checkbox"/> <input type="checkbox"/> <input type="checkbox"/> <input type="checkbox"/> MWM HYSTERESIS			50	288	50	
<input type="checkbox"/> <input type="checkbox"/> <input type="checkbox"/> <input type="checkbox"/> BOOSTER TIMEOUT		min	0	360	90	
<input type="checkbox"/> <input type="checkbox"/> <input type="checkbox"/> <input type="checkbox"/> BOOSTER T ACTIVATE		°C	-20	10	-10	
<input type="checkbox"/> <input type="checkbox"/> <input type="checkbox"/> <input type="checkbox"/> PASTEURISATION		d	1	30	30	
<input type="checkbox"/> <input type="checkbox"/> <input type="checkbox"/> <input type="checkbox"/> MAX DHW HTG DUR.		h	6	12	12	
<input type="checkbox"/> <input type="checkbox"/> <input type="checkbox"/> <input type="checkbox"/> PASTEURISATION TEMP.		°C	10	65	30	
<input type="checkbox"/> <input type="checkbox"/> <input type="checkbox"/> <input type="checkbox"/> PASTEURISATION TIME			00:00	23:45	02:00	
<input type="checkbox"/> <input type="checkbox"/> <input type="checkbox"/> <input type="checkbox"/> DHW BOOSTER STAGE			0	3	3	
<input type="checkbox"/> <input type="checkbox"/> <input type="checkbox"/> <input type="checkbox"/> DHW BUFFER MODE	OFF ON		OFF	ON	OFF	
<input type="checkbox"/> <input type="checkbox"/> <input type="checkbox"/> <input type="checkbox"/> MAX FLOW TEMP DHW		°C	10	75	75	
<input type="checkbox"/> <input type="checkbox"/> <input type="checkbox"/> <input type="checkbox"/> DHW ECO	OFF ON		0	1	1	
<input type="checkbox"/> <input type="checkbox"/> <input type="checkbox"/> <input type="checkbox"/> DHW OUTPUT SUMMER		%	30	100	60	
<input type="checkbox"/> <input type="checkbox"/> <input type="checkbox"/> <input type="checkbox"/> DHW OUTPUT WINTER		%	30	100	60	
<input type="checkbox"/> <input type="checkbox"/> <input type="checkbox"/> <input type="checkbox"/> INTEGRAL SENSOR	OFF ON CONTROL				OFF	
<input type="checkbox"/> <input type="checkbox"/> <input type="checkbox"/> <input type="checkbox"/> INTEGRAL SENSOR CLASS			-8	8	0	
<input type="checkbox"/> <input type="checkbox"/> <input type="checkbox"/> <input type="checkbox"/> 2ND DHW CYLINDER	OFF ON				OFF	
<input type="checkbox"/> <input type="checkbox"/> <input type="checkbox"/> VENTILATION						
<input type="checkbox"/> <input type="checkbox"/> <input type="checkbox"/> <input type="checkbox"/> FAN CONTROL	FLOW RATE DIFFERENTIAL PRESSURE				FLOW RATE	
<input type="checkbox"/> <input type="checkbox"/> <input type="checkbox"/> <input type="checkbox"/> DIFFERENTIAL PRESSURE						
<input type="checkbox"/> <input type="checkbox"/> <input type="checkbox"/> <input type="checkbox"/> SET DIFFERENTIAL PRESSURE		Pa	20	100	60	
<input type="checkbox"/> <input type="checkbox"/> <input type="checkbox"/> <input type="checkbox"/> I FACTOR		Pa s m ³	1	10	2	
<input type="checkbox"/> <input type="checkbox"/> <input type="checkbox"/> <input type="checkbox"/> P FACTOR		Pa/m ³	1	10	2	
<input type="checkbox"/> <input type="checkbox"/> <input type="checkbox"/> <input type="checkbox"/> VENTILATION STAGES						
<input type="checkbox"/> <input type="checkbox"/> <input type="checkbox"/> <input type="checkbox"/> DAY STAGE			0	3	2 (Delivered condition: 0)	
<input type="checkbox"/> <input type="checkbox"/> <input type="checkbox"/> <input type="checkbox"/> NIGHT STAGE			0	3	1 (Delivered condition: 0)	
<input type="checkbox"/> <input type="checkbox"/> <input type="checkbox"/> <input type="checkbox"/> STANDBY STAGE			0	3	0 (Delivered condition: 0)	
<input type="checkbox"/> <input type="checkbox"/> <input type="checkbox"/> <input type="checkbox"/> PARTY STAGE			0	3	3 (Delivered condition: 0)	
<input type="checkbox"/> <input type="checkbox"/> <input type="checkbox"/> <input type="checkbox"/> MANUAL STAGE			0	3	2 (Delivered condition: 0)	
<input type="checkbox"/> <input type="checkbox"/> <input type="checkbox"/> <input type="checkbox"/> VENTILATION TIMES						
<input type="checkbox"/> <input type="checkbox"/> <input type="checkbox"/> <input type="checkbox"/> UNSCHED. VENT TIME STAGE 0		min	0	1000	60	
<input type="checkbox"/> <input type="checkbox"/> <input type="checkbox"/> <input type="checkbox"/> UNSCHED. VENT TIME STAGE 1		min	0	1000	60	
<input type="checkbox"/> <input type="checkbox"/> <input type="checkbox"/> <input type="checkbox"/> UNSCHED. VENT TIME STAGE 2		min	0	1000	60	
<input type="checkbox"/> <input type="checkbox"/> <input type="checkbox"/> <input type="checkbox"/> UNSCHED. VENT TIME STAGE 3		min	0	1000	60	
<input type="checkbox"/> <input type="checkbox"/> <input type="checkbox"/> <input type="checkbox"/> FLOW RATE						

OPERATION

Menu structure

Menu item/parameter	Options	Unit	Min.	Max.	Standard	System value
<input type="checkbox"/> <input type="checkbox"/> <input type="checkbox"/> FAN STAGE VENT. AIR 1		m ³ /h	10	300	140	
<input type="checkbox"/> <input type="checkbox"/> <input type="checkbox"/> FAN STAGE VENT. AIR 2		m ³ /h	80	300	170	
<input type="checkbox"/> <input type="checkbox"/> <input type="checkbox"/> FAN STAGE VENT. AIR 3		m ³ /h	80	300	220	
<input type="checkbox"/> <input type="checkbox"/> <input type="checkbox"/> FAN STG. EXTRACT AIR 1		m ³ /h	10	300	140	
<input type="checkbox"/> <input type="checkbox"/> <input type="checkbox"/> FAN STG. EXTRACT AIR 2		m ³ /h	80	300	170	
<input type="checkbox"/> <input type="checkbox"/> <input type="checkbox"/> FAN STG. EXTRACT AIR 3		m ³ /h	80	300	220	
<input type="checkbox"/> <input type="checkbox"/> PASSIVE COOLING						
<input type="checkbox"/> <input type="checkbox"/> <input type="checkbox"/> PASSIVE COOLING	OFF EXTRACT AIR SUPPLY AIR BYPASS SUMMER CASSETTE				OFF	
<input type="checkbox"/> <input type="checkbox"/> <input type="checkbox"/> PASS. COOL EXP. AIR	OFF ON				OFF	
<input type="checkbox"/> <input type="checkbox"/> <input type="checkbox"/> AIR STOP SUMMER DHW	OFF ON				OFF	
<input type="checkbox"/> <input type="checkbox"/> HUMIDITY PROTECTION						
<input type="checkbox"/> <input type="checkbox"/> <input type="checkbox"/> HUMIDITY PROTECTION	OFF ON				OFF	
<input type="checkbox"/> <input type="checkbox"/> <input type="checkbox"/> HUM. THRESHOLD VALUE		%	30	70	55	
<input type="checkbox"/> <input type="checkbox"/> <input type="checkbox"/> HUMIDITY HYSTERESIS		%	2	10	5	
<input type="checkbox"/> <input type="checkbox"/> <input type="checkbox"/> HUM. MASKING TIME		min	1	10	5	
<input type="checkbox"/> <input type="checkbox"/> <input type="checkbox"/> SET HUMIDITY MIN		%	30	60	50	
<input type="checkbox"/> <input type="checkbox"/> <input type="checkbox"/> OUTPUT REDUCTION		%	0	50	0	
<input type="checkbox"/> <input type="checkbox"/> <input type="checkbox"/> SET HUMIDITY MAX		%	60	90	60	
<input type="checkbox"/> <input type="checkbox"/> <input type="checkbox"/> OUTPUT INCREASE		%	0	100	0	
<input type="checkbox"/> <input type="checkbox"/> STOVE / FIREPLACE	OFF N/O CONTACT OFF N/C CONTACT OFF N/O MONITORING N/C MONITORING				OFF	
<input type="checkbox"/> <input type="checkbox"/> AIR/AIR HE						
<input type="checkbox"/> <input type="checkbox"/> <input type="checkbox"/> MAX DEFROST DUR.		min	60	250	60	
<input type="checkbox"/> <input type="checkbox"/> <input type="checkbox"/> DEFR START THRESHOLD			0	50	20	
<input type="checkbox"/> <input type="checkbox"/> <input type="checkbox"/> FILTER SPEED			0	100	20	
<input type="checkbox"/> <input type="checkbox"/> <input type="checkbox"/> FILTER CHANGE VOLUME		1000 m ³	180	650		
<input type="checkbox"/> <input type="checkbox"/> SERVICE						
<input type="checkbox"/> <input type="checkbox"/> <input type="checkbox"/> RUNTIME FILTER		d	0	1024	0	
<input type="checkbox"/> <input type="checkbox"/> <input type="checkbox"/> RESET FILTER	OFF ON				OFF	
<input type="checkbox"/> COOLING						
<input type="checkbox"/> <input type="checkbox"/> ROOM TEMPERATURES HC1						
<input type="checkbox"/> <input type="checkbox"/> <input type="checkbox"/> ROOM TEMPERATURE DAY HC1		°C	10	30	25	
<input type="checkbox"/> <input type="checkbox"/> <input type="checkbox"/> ROOM TEMP. NIGHT HC1		°C	10	30	25	
<input type="checkbox"/> <input type="checkbox"/> <input type="checkbox"/> ROOM TEMP. STANDBY HC1		°C	10	30	30	
<input type="checkbox"/> <input type="checkbox"/> <input type="checkbox"/> ROOM TEMPERATURE HC1		°C				
<input type="checkbox"/> <input type="checkbox"/> ROOM TEMPERATURES HC2						
<input type="checkbox"/> <input type="checkbox"/> <input type="checkbox"/> ROOM TEMPERATURE DAY HC2		°C	10	30	25	
<input type="checkbox"/> <input type="checkbox"/> <input type="checkbox"/> ROOM TEMP. NIGHT HC2		°C	10	30	25	
<input type="checkbox"/> <input type="checkbox"/> <input type="checkbox"/> ROOM TEMP. STANDBY HC2		°C	10	30	30	
<input type="checkbox"/> <input type="checkbox"/> <input type="checkbox"/> ROOM TEMPERATURE HC2		°C				
<input type="checkbox"/> <input type="checkbox"/> COOLING MODE HC1						
<input type="checkbox"/> <input type="checkbox"/> <input type="checkbox"/> COOLING MODE HC1					OFF	
<input type="checkbox"/> <input type="checkbox"/> <input type="checkbox"/> COOLING SYSTEM HC1	AREA COOLING FAN COOLING				AREA COOLING	
<input type="checkbox"/> <input type="checkbox"/> <input type="checkbox"/> HC TEMP. COOLING HC1		°C	10	25	18	
<input type="checkbox"/> <input type="checkbox"/> <input type="checkbox"/> HYST. ROOM TEMP. HC1		K	0.5	3	0.5	
<input type="checkbox"/> <input type="checkbox"/> COOLING MODE HC2						
<input type="checkbox"/> <input type="checkbox"/> <input type="checkbox"/> COOLING MODE HC2	OFF ON		OFF	ON	OFF	
<input type="checkbox"/> <input type="checkbox"/> <input type="checkbox"/> COOLING SYSTEM HC2	AREA COOLING FAN COOLING				AREA COOLING	
<input type="checkbox"/> <input type="checkbox"/> <input type="checkbox"/> HC TEMP. COOLING HC2		°C	10	25	18	
<input type="checkbox"/> <input type="checkbox"/> <input type="checkbox"/> HYST. ROOM TEMP. HC2		K	0.5	3	0.5	
<input type="checkbox"/> <input type="checkbox"/> STANDARD SETTING						
<input type="checkbox"/> <input type="checkbox"/> <input type="checkbox"/> COOLING CAPACITY		%	30	50	30	
<input type="checkbox"/> <input type="checkbox"/> <input type="checkbox"/> HYST. FLOW TEMP.		K	0.5	5	1.5	
<input type="checkbox"/> SOLAR THERMAL						
<input type="checkbox"/> <input type="checkbox"/> SOLAR ACTIVATION	OFF ON		OFF	ON	OFF	
<input type="checkbox"/> <input type="checkbox"/> TEMP. DIFFERENTIAL		K	2	15	8	
<input type="checkbox"/> <input type="checkbox"/> DHW COMPRESSOR DELAY		min	0	500	60	
<input type="checkbox"/> <input type="checkbox"/> DHW SOLAR TEMP.		°C	10	75	60	
<input type="checkbox"/> <input type="checkbox"/> SOLAR HYSTERESIS		K	0.6	10	5	
<input type="checkbox"/> <input type="checkbox"/> COLLECTOR TEMP LIMIT		°C	50	80	70	
<input type="checkbox"/> <input type="checkbox"/> COLL. PROTECT TEMP		°C	100	150	120	
<input type="checkbox"/> <input type="checkbox"/> COLL. CUT-OFF TEMP		°C	130	200	180	
<input type="checkbox"/> <input type="checkbox"/> COLLECTOR PROTECTION	OFF ON				OFF	
<input type="checkbox"/> <input type="checkbox"/> PRIORITY SOLAR	SOLAR THERMAL COOLING COOLING TIME				SOLAR THERMAL	

OPERATION

Menu structure

Menu item/parameter	Options	Unit	Min.	Max.	Standard	System value
<input type="checkbox"/> <input type="checkbox"/> <input type="checkbox"/> <input type="checkbox"/> COOLING TIME						
<input type="checkbox"/> <input type="checkbox"/> <input type="checkbox"/> <input type="checkbox"/> START			00:00	23:59		
<input type="checkbox"/> <input type="checkbox"/> <input type="checkbox"/> <input type="checkbox"/> END			00:00	23:59		
<input type="checkbox"/> <input type="checkbox"/> SCREED DRYING PROG.						
<input type="checkbox"/> <input type="checkbox"/> <input type="checkbox"/> START	OFF ON				OFF	
<input type="checkbox"/> <input type="checkbox"/> <input type="checkbox"/> LOW END TEMPERATURE		K	20	40	25	
<input type="checkbox"/> <input type="checkbox"/> <input type="checkbox"/> HIGH END TEMPERATURE		K	25	55	40	
<input type="checkbox"/> <input type="checkbox"/> <input type="checkbox"/> TEMP. RISE PERIOD		d	0	30	3	
<input type="checkbox"/> <input type="checkbox"/> <input type="checkbox"/> MAX HUT TIME		d	0	30	3	
<input type="checkbox"/> <input type="checkbox"/> <input type="checkbox"/> GRADIENT		K/d	1	10	1	
<input type="checkbox"/> <input type="checkbox"/> COMMISSIONING						
<input type="checkbox"/> <input type="checkbox"/> <input type="checkbox"/> PROGRAMMING UNIT						
<input type="checkbox"/> <input type="checkbox"/> <input type="checkbox"/> <input type="checkbox"/> CONTROL UNIT SOFTWARE						
<input type="checkbox"/> <input type="checkbox"/> <input type="checkbox"/> <input type="checkbox"/> CONTRAST						
<input type="checkbox"/> <input type="checkbox"/> <input type="checkbox"/> <input type="checkbox"/> BRIGHTNESS						
<input type="checkbox"/> <input type="checkbox"/> <input type="checkbox"/> <input type="checkbox"/> TOUCH SENSITIVITY						
<input type="checkbox"/> <input type="checkbox"/> <input type="checkbox"/> <input type="checkbox"/> TOUCH ACCELERATION						
<input type="checkbox"/> <input type="checkbox"/> <input type="checkbox"/> <input type="checkbox"/> LANGUAGE	Deutsch English Francais Nederlands Italiano Svenska Polski Cestina Magyar Espanyol Suomi Dansk				DEUTSCH	
<input type="checkbox"/> <input type="checkbox"/> <input type="checkbox"/> <input type="checkbox"/> TERMINAL ADDRESS			1	4	4	
<input type="checkbox"/> <input type="checkbox"/> <input type="checkbox"/> <input type="checkbox"/> HC ROOM T DETECTOR	NONE HC1 HC2				NONE	
<input type="checkbox"/> <input type="checkbox"/> <input type="checkbox"/> <input type="checkbox"/> ROOM TEMP CORRECTION	ROOM TEMP CORRECTION ROOM TEMP CORRECTION HC1 ROOM TEMP CORRECTION HC2	°C	-5	5	0	
<input type="checkbox"/> <input type="checkbox"/> <input type="checkbox"/> <input type="checkbox"/> REL HUMIDITY CORRECTION		%	-5	5	0	
<input type="checkbox"/> <input type="checkbox"/> <input type="checkbox"/> CONTROLLER						
<input type="checkbox"/> <input type="checkbox"/> <input type="checkbox"/> <input type="checkbox"/> SOFTWARE VERSION						
<input type="checkbox"/> <input type="checkbox"/> <input type="checkbox"/> <input type="checkbox"/> SOFTWARE ID						
<input type="checkbox"/> <input type="checkbox"/> <input type="checkbox"/> <input type="checkbox"/> RESET CONTROLLER	OFF ON				OFF	
<input type="checkbox"/> <input type="checkbox"/> <input type="checkbox"/> <input type="checkbox"/> FACTORY SETTING	OFF ON				OFF	
<input type="checkbox"/> <input type="checkbox"/> <input type="checkbox"/> <input type="checkbox"/> APPLIANCE TYPE			0	37		
<input type="checkbox"/> <input type="checkbox"/> <input type="checkbox"/> TIME / DATE						
<input type="checkbox"/> <input type="checkbox"/> <input type="checkbox"/> TIME / DATE						
<input type="checkbox"/> <input type="checkbox"/> <input type="checkbox"/> <input type="checkbox"/> DAY			1	31	1	
<input type="checkbox"/> <input type="checkbox"/> <input type="checkbox"/> <input type="checkbox"/> MONTH			1	12	1	
<input type="checkbox"/> <input type="checkbox"/> <input type="checkbox"/> <input type="checkbox"/> YEAR			0	99	0	
<input type="checkbox"/> <input type="checkbox"/> <input type="checkbox"/> <input type="checkbox"/> HOUR			0	23	0	
<input type="checkbox"/> <input type="checkbox"/> <input type="checkbox"/> <input type="checkbox"/> MINUTE			0	59	0	
<input type="checkbox"/> <input type="checkbox"/> <input type="checkbox"/> <input type="checkbox"/> SUMMERTIME MANUAL						
<input type="checkbox"/> <input type="checkbox"/> <input type="checkbox"/> <input type="checkbox"/> DAY BEGINNING						
<input type="checkbox"/> <input type="checkbox"/> <input type="checkbox"/> <input type="checkbox"/> <input type="checkbox"/> DAY			1	31	21	
<input type="checkbox"/> <input type="checkbox"/> <input type="checkbox"/> <input type="checkbox"/> <input type="checkbox"/> MONTH			1	12	3	
<input type="checkbox"/> <input type="checkbox"/> <input type="checkbox"/> <input type="checkbox"/> DAY ENDING						
<input type="checkbox"/> <input type="checkbox"/> <input type="checkbox"/> <input type="checkbox"/> <input type="checkbox"/> DAY			1	31	25	
<input type="checkbox"/> <input type="checkbox"/> <input type="checkbox"/> <input type="checkbox"/> <input type="checkbox"/> MONTH			1	12	10	
<input type="checkbox"/> <input type="checkbox"/> <input type="checkbox"/> <input type="checkbox"/> SUMMERTIME AUTOMATIC	OFF ON				ON	
<input checked="" type="checkbox"/> <input type="checkbox"/> <input type="checkbox"/> <input type="checkbox"/> CONTRACTOR						
<input type="checkbox"/> <input type="checkbox"/> <input type="checkbox"/> <input type="checkbox"/> ENTER CODE						
<input type="checkbox"/> <input type="checkbox"/> <input type="checkbox"/> <input type="checkbox"/> FAULT SEARCH						
<input type="checkbox"/> <input type="checkbox"/> <input type="checkbox"/> <input type="checkbox"/> FAULT LIST						
<input type="checkbox"/> <input type="checkbox"/> <input type="checkbox"/> <input type="checkbox"/> DELETE FAULT MEMORY	OFF ON				OFF	
<input type="checkbox"/> <input type="checkbox"/> <input type="checkbox"/> <input type="checkbox"/> STOP EVENT			0	64	0	
<input type="checkbox"/> <input type="checkbox"/> <input type="checkbox"/> <input type="checkbox"/> SWITCH ON MANUALLY						
<input type="checkbox"/> <input type="checkbox"/> <input type="checkbox"/> <input type="checkbox"/> CONTROL VALVE HTG	OFF ON				OFF	
<input type="checkbox"/> <input type="checkbox"/> <input type="checkbox"/> <input type="checkbox"/> CONTROL VALVE DHW	OFF ON				OFF	
<input type="checkbox"/> <input type="checkbox"/> <input type="checkbox"/> <input type="checkbox"/> SOLAR PUMP	OFF ON				OFF	
<input type="checkbox"/> <input type="checkbox"/> <input type="checkbox"/> <input type="checkbox"/> MIXER PUMP	OFF ON				OFF	
<input type="checkbox"/> <input type="checkbox"/> <input type="checkbox"/> <input type="checkbox"/> MIXER OPEN	OFF ON				OFF	
<input type="checkbox"/> <input type="checkbox"/> <input type="checkbox"/> <input type="checkbox"/> MIXER CLOSE	OFF ON				OFF	
<input type="checkbox"/> <input type="checkbox"/> <input type="checkbox"/> <input type="checkbox"/> DIVERTER VALVE	OFF ON				OFF	
<input type="checkbox"/> <input type="checkbox"/> <input type="checkbox"/> <input type="checkbox"/> COMPRESSOR	OFF ON				OFF	
<input type="checkbox"/> <input type="checkbox"/> <input type="checkbox"/> <input type="checkbox"/> BOOSTER STAGE 1	OFF ON				OFF	
<input type="checkbox"/> <input type="checkbox"/> <input type="checkbox"/> <input type="checkbox"/> BOOSTER STAGE 2	OFF ON				OFF	
<input type="checkbox"/> <input type="checkbox"/> <input type="checkbox"/> <input type="checkbox"/> BOOSTER STAGE 3	OFF ON				OFF	
<input type="checkbox"/> <input type="checkbox"/> <input type="checkbox"/> <input type="checkbox"/> EXTR. AIR FAN SPEED	OFF ON				OFF	

OPERATION

Menu structure

Menu item/parameter	Options	Unit	Min.	Max.	Standard	System value
<input type="checkbox"/> <input type="checkbox"/> <input type="checkbox"/> SUPPLY AIR FAN SPEED	OFF ON				OFF	
<input type="checkbox"/> <input type="checkbox"/> <input type="checkbox"/> WINDOW OPEN	OFF ON				OFF	
<input type="checkbox"/> <input type="checkbox"/> <input type="checkbox"/> CONTACT COOLING	OFF ON				OFF	
<input type="checkbox"/> <input type="checkbox"/> <input type="checkbox"/> 2ND DHW CYLINDER	OFF ON				OFF	
<input type="checkbox"/> <input type="checkbox"/> <input type="checkbox"/> OIL SUMP HEATING	OFF ON				OFF	
<input type="checkbox"/> <input type="checkbox"/> EVAPORATOR						
<input type="checkbox"/> <input type="checkbox"/> <input type="checkbox"/> DEFROST END TEMP.		°C	0	30	30	
<input type="checkbox"/> <input type="checkbox"/> <input type="checkbox"/> MAX DEFROST DUR.		min	2	60	10	
<input type="checkbox"/> <input type="checkbox"/> <input type="checkbox"/> BOOSTER REFR. GUARD		°C	10	30	15	
<input type="checkbox"/> <input type="checkbox"/> <input type="checkbox"/> DEFROST STOP		°C	0	20	10	
<input type="checkbox"/> <input type="checkbox"/> REFRIGERATION UNIT						
<input type="checkbox"/> <input type="checkbox"/> <input type="checkbox"/> COMPRESSOR CYCLING		min	0	20	20	
<input type="checkbox"/> <input type="checkbox"/> <input type="checkbox"/> EXHAUST AIR SPEED			10	100	60	
<input type="checkbox"/> <input type="checkbox"/> <input type="checkbox"/> STARTING CURR. LIMTR		A	5	30	20	
<input type="checkbox"/> <input type="checkbox"/> VENTILATION						
<input type="checkbox"/> <input type="checkbox"/> <input type="checkbox"/> FAN TYPE	0-2 (EBM / FLQ140 / FLQ160)					
<input type="checkbox"/> <input type="checkbox"/> <input type="checkbox"/> PUMPS						
<input type="checkbox"/> <input type="checkbox"/> <input type="checkbox"/> PUMP SPEED DHW		%	40	100	80	
<input type="checkbox"/> <input type="checkbox"/> <input type="checkbox"/> PUMP SPEED HEATING		%	40	100	80	
<input type="checkbox"/> <input type="checkbox"/> <input type="checkbox"/> MIXER/HEATING RATIO		%	0	100	100	
<input type="checkbox"/> <input type="checkbox"/> <input type="checkbox"/> MIXER P. RUN-ON		min	0	120	10	
<input type="checkbox"/> <input type="checkbox"/> <input type="checkbox"/> MIXER P. TYPE			0	2	0	
<input type="checkbox"/> <input type="checkbox"/> <input type="checkbox"/> SOLAR P. TYPE			0	2	0	
<input type="checkbox"/> <input type="checkbox"/> <input type="checkbox"/> PUMP CYCLES						
<input type="checkbox"/> <input type="checkbox"/> <input type="checkbox"/> MINIMUM CYCLES		1/d	1	24	1	
<input type="checkbox"/> <input type="checkbox"/> <input type="checkbox"/> MAXIMUM CYCLES		1/d	25	288	100	
<input type="checkbox"/> <input type="checkbox"/> <input type="checkbox"/> OUTSIDE TEMP MIN CYC		°C	0	25	20	
<input type="checkbox"/> <input type="checkbox"/> <input type="checkbox"/> OUTSIDE TEMP MAX CYC		°C	0	20	0	
<input type="checkbox"/> <input type="checkbox"/> <input type="checkbox"/> EMERGENCY MODE AUTO	OFF ON				OFF	
<input type="checkbox"/> <input type="checkbox"/> <input type="checkbox"/> POWER-OFF			0	5	5	
<input type="checkbox"/> <input type="checkbox"/> <input type="checkbox"/> PROCESS VALUES						
<input type="checkbox"/> <input type="checkbox"/> <input type="checkbox"/> FAN (PRC)		%				
<input type="checkbox"/> <input type="checkbox"/> <input type="checkbox"/> OUTSIDE TEMPERATURE		°C				
<input type="checkbox"/> <input type="checkbox"/> <input type="checkbox"/> EVAP. OUTLET TEMP.		°C				
<input type="checkbox"/> <input type="checkbox"/> <input type="checkbox"/> HOT GAS TEMPERATURE		°C				
<input type="checkbox"/> <input type="checkbox"/> <input type="checkbox"/> FLOW TEMPERATURE		°C				
<input type="checkbox"/> <input type="checkbox"/> <input type="checkbox"/> CONDENSER TEMP.		°C				
<input type="checkbox"/> <input type="checkbox"/> <input type="checkbox"/> RETURN TEMPERATURE		°C				
<input type="checkbox"/> <input type="checkbox"/> <input type="checkbox"/> COOLING TEMP.		°C				
<input type="checkbox"/> <input type="checkbox"/> <input type="checkbox"/> HIGH PRESSURE		bar				
<input type="checkbox"/> <input type="checkbox"/> <input type="checkbox"/> LOW PRESSURE		bar				
<input type="checkbox"/> <input type="checkbox"/> <input type="checkbox"/> LP FILTERED		bar				
<input type="checkbox"/> <input type="checkbox"/> <input type="checkbox"/> POSITION VALVE						
<input type="checkbox"/> <input type="checkbox"/> <input type="checkbox"/> PWM SOLAR PUMP		%				
<input type="checkbox"/> <input type="checkbox"/> <input type="checkbox"/> PWM HTG CIRCUIT PUMP		%				
<input type="checkbox"/> <input type="checkbox"/> <input type="checkbox"/> PWM MIXER PUMP		%				
<input type="checkbox"/> <input type="checkbox"/> <input type="checkbox"/> HTG OUTPUT RELATIVE		%				
<input type="checkbox"/> <input type="checkbox"/> <input type="checkbox"/> COMPRESSOR SET OUTPUT		%				
<input type="checkbox"/> <input type="checkbox"/> <input type="checkbox"/> COMP. N SET VAL UNLTD		Hz				
<input type="checkbox"/> <input type="checkbox"/> <input type="checkbox"/> COMP. N SET VAL LTD		Hz				
<input type="checkbox"/> <input type="checkbox"/> <input type="checkbox"/> PROCESS STATUS						
<input type="checkbox"/> <input type="checkbox"/> <input type="checkbox"/> HP SWITCH	OFF ON					
<input type="checkbox"/> <input type="checkbox"/> <input type="checkbox"/> MOTOR PROTECTION	OFF ON					
<input type="checkbox"/> <input type="checkbox"/> <input type="checkbox"/> DEFROST SIGNAL	OFF ON					
<input type="checkbox"/> <input type="checkbox"/> <input type="checkbox"/> COMPRESSOR	OFF ON					
<input type="checkbox"/> <input type="checkbox"/> <input type="checkbox"/> DHC 1	OFF ON					
<input type="checkbox"/> <input type="checkbox"/> <input type="checkbox"/> DHC 2	OFF ON					
<input type="checkbox"/> <input type="checkbox"/> <input type="checkbox"/> DHC 3	OFF ON					
<input type="checkbox"/> <input type="checkbox"/> <input type="checkbox"/> DEFROST VALVE	OFF ON					
<input type="checkbox"/> <input type="checkbox"/> <input type="checkbox"/> FAN	OFF ON					
<input type="checkbox"/> <input type="checkbox"/> <input type="checkbox"/> COOLING	OFF ON					
<input type="checkbox"/> <input type="checkbox"/> <input type="checkbox"/> POWER-OFF	OFF ON					
<input type="checkbox"/> <input type="checkbox"/> <input type="checkbox"/> STOVE / FIREPLACE	OFF ON					
<input type="checkbox"/> <input type="checkbox"/> <input type="checkbox"/> ANALYSIS						

OPERATION

Menu structure

Menu item/parameter	Options	Unit	Min.	Max.	Standard	System value
<input type="checkbox"/> <input type="checkbox"/> <input checked="" type="checkbox"/> CURRENT MODE IWS						
<input type="checkbox"/> <input type="checkbox"/> <input checked="" type="checkbox"/> CURRENT MODE EVE						
<input type="checkbox"/> <input type="checkbox"/> <input checked="" type="checkbox"/> SUPERHTG EVAP. SET		°C				
<input type="checkbox"/> <input type="checkbox"/> <input checked="" type="checkbox"/> SUPERHTG EVAP ACTUAL		°C				
<input type="checkbox"/> <input type="checkbox"/> <input checked="" type="checkbox"/> SUPERHTG RECUP. ACT.		°C				
<input type="checkbox"/> <input type="checkbox"/> <input checked="" type="checkbox"/> CYCLING REL.		%				
<input type="checkbox"/> <input type="checkbox"/> <input checked="" type="checkbox"/> DYNAMIC FACTOR						
<input type="checkbox"/> <input type="checkbox"/> <input checked="" type="checkbox"/> P FACTOR						
<input type="checkbox"/> <input type="checkbox"/> <input checked="" type="checkbox"/> I FACTOR						
<input type="checkbox"/> <input type="checkbox"/> <input checked="" type="checkbox"/> D FACTOR						
<input type="checkbox"/> <input type="checkbox"/> <input checked="" type="checkbox"/> OPENING EXV PRE-CTRL		%				
<input type="checkbox"/> <input type="checkbox"/> <input checked="" type="checkbox"/> OPENING EXV		%				
<input type="checkbox"/> <input type="checkbox"/> <input checked="" type="checkbox"/> OPENING EXV COOLING		%				
<input type="checkbox"/> <input type="checkbox"/> <input checked="" type="checkbox"/> ACTUAL HTG/COOL OUTPUT		kW				
<input type="checkbox"/> <input checked="" type="checkbox"/> INVERTER						
<input type="checkbox"/> <input type="checkbox"/> <input checked="" type="checkbox"/> COMPRESSOR SPEED		Hz				
<input type="checkbox"/> <input type="checkbox"/> <input checked="" type="checkbox"/> MOTOR CURRENT		A				
<input type="checkbox"/> <input type="checkbox"/> <input checked="" type="checkbox"/> MOTOR POWER		kW				
<input type="checkbox"/> <input type="checkbox"/> <input checked="" type="checkbox"/> MOTOR VOLTAGE		V				
<input type="checkbox"/> <input type="checkbox"/> <input checked="" type="checkbox"/> INVERTER TEMPERATURE		°C				
<input type="checkbox"/> <input type="checkbox"/> <input checked="" type="checkbox"/> INVERTER FAULT						

Guarantee

The guarantee conditions of our German companies do not apply to appliances acquired outside of Germany. In countries where our subsidiaries sell our products a guarantee can only be issued by those subsidiaries. Such guarantee is only granted if the subsidiary has issued its own terms of guarantee. No other guarantee will be granted.

We shall not provide any guarantee for appliances acquired in countries where we have no subsidiary to sell our products. This will not affect warranties issued by any importers.

Environment and recycling

We would ask you to help protect the environment. After use, dispose of the various materials in accordance with national regulations.

NOTES

Deutschland

STIEBEL ELTRON GmbH & Co. KG
Dr.-Stiebel-Straße 33 | 37603 Holzminden
Tel. 05531 702-0 | Fax 05531 702-480
info@stiebel-eltron.de
www.stiebel-eltron.de

Verkauf

Tel. 05531 702-110 | Fax 05531 702-95108 | info-center@stiebel-eltron.de

Kundendienst

Tel. 05531 702-111 | Fax 05531 702-95890 | kundendienst@stiebel-eltron.de

Ersatzteilverkauf

Tel. 05531 702-120 | Fax 05531 702-95335 | ersatzteile@stiebel-eltron.de

Australia

STIEBEL ELTRON Australia Pty. Ltd.
294 Salmon Street | Port Melbourne VIC 3207
Tel. 03 9645-1833 | Fax 03 9644-5091
info@stiebel-eltron.com.au
www.stiebel-eltron.com.au

Austria

STIEBEL ELTRON Ges.m.b.H.
Gewerbegebiet Neubau-Nord
Margaritenstraße 4 A | 4063 Hörsching
Tel. 07221 74600-0 | Fax 07221 74600-42
info@stiebel-eltron.at
www.stiebel-eltron.at

Belgium

STIEBEL ELTRON bvba/sprl
't Hofveld 6 - D1 | 1702 Groot-Bijgaarden
Tel. 02 42322-22 | Fax 02 42322-12
info@stiebel-eltron.be
www.stiebel-eltron.be

China

STIEBEL ELTRON (Tianjin) Electric Appliance
Co., Ltd.
Plant C3, XEDA International Industry City
Xiqing Economic Development Area
300085 Tianjin
Tel. 022 8396 2077 | Fax 022 8396 2075
info@stiebel-eltron.cn
www.stiebel-eltron.cn

Czech Republic

STIEBEL ELTRON spol. s r.o.
Dopraváků 749/3 | 184 00 Praha 8
Tel. 251116-111 | Fax 235512-122
info@stiebel-eltron.cz
www.stiebel-eltron.cz

Finland

STIEBEL ELTRON OY
Kapinakuja 1 | 04600 Mäntsälä
Tel. 020 720-9988
info@stiebel-eltron.fi
www.stiebel-eltron.fi

France

STIEBEL ELTRON SAS
7-9, rue des Selliers
B.P 85107 | 57073 Metz-Cédex 3
Tel. 0387 7438-88 | Fax 0387 7468-26
info@stiebel-eltron.fr
www.stiebel-eltron.fr

Hungary

STIEBEL ELTRON Kft.
Gyár u. 2 | 2040 Budaörs
Tel. 01 250-6055 | Fax 01 368-8097
info@stiebel-eltron.hu
www.stiebel-eltron.hu

Japan

NIHON STIEBEL Co. Ltd.
Kowa Kawasaki Nishiguchi Building 8F
66-2 Horikawa-Cho
Saiwai-Ku | 212-0013 Kawasaki
Tel. 044 540-3200 | Fax 044 540-3210
info@nihonstiebel.co.jp
www.nihonstiebel.co.jp

Netherlands

STIEBEL ELTRON Nederland B.V.
Daviottenweg 36 | 5222 BH 's-Hertogenbosch
Tel. 073 623-0000 | Fax 073 623-1141
info@stiebel-eltron.nl
www.stiebel-eltron.nl

Poland

STIEBEL ELTRON Polska Sp. z O.O.
ul. Działkowa 2 | 02-234 Warszawa
Tel. 022 60920-30 | Fax 022 60920-29
biuro@stiebel-eltron.pl
www.stiebel-eltron.pl

Russia

STIEBEL ELTRON LLC RUSSIA
Urzhumskaya street 4,
building 2 | 129343 Moscow
Tel. 0495 7753889 | Fax 0495 7753887
info@stiebel-eltron.ru
www.stiebel-eltron.ru

Slovakia

STIEBEL ELTRON Slovakia, s.r.o.
Hlavná 1 | 058 01 Poprad
Tel. 052 7127-125 | Fax 052 7127-148
info@stiebel-eltron.sk
www.stiebel-eltron.sk

Switzerland

STIEBEL ELTRON AG
Industrie West
Gass 8 | 5242 Lupfig
Tel. 056 4640-500 | Fax 056 4640-501
info@stiebel-eltron.ch
www.stiebel-eltron.ch

Thailand

STIEBEL ELTRON Asia Ltd.
469 Moo 2 Tambol Klong-Jik
Amphur Bangpa-In | 13160 Ayutthaya
Tel. 035 220088 | Fax 035 221188
info@stiebel-eltronasia.com
www.stiebel-eltronasia.com

United Kingdom and Ireland

STIEBEL ELTRON UK Ltd.
Unit 12 Stadium Court
Stadium Road | CH62 3RP Bromborough
Tel. 0151 346-2300 | Fax 0151 334-2913
info@stiebel-eltron.co.uk
www.stiebel-eltron.co.uk

United States of America

STIEBEL ELTRON, Inc.
17 West Street | 01088 West Hatfield MA
Tel. 0413 247-3380 | Fax 0413 247-3369
info@stiebel-eltron-usa.com
www.stiebel-eltron-usa.com

STIEBEL ELTRON



Irrtum und technische Änderungen vorbehalten! | Subject to errors and technical changes! | Sous réserve d'erreurs et de modifications techniques! | Onder voorbehoud van vergissingen en technische wijzigingen! | Salvo error o modificación técnica! | Excepto erro ou alteração técnica | Zastrzeżone zmiany techniczne i ewentualne błędy | Omyly a technické změny jsou vyhrazeny! | A muszáki változtatások és tévedések jogát fenntartjuk! | Отсутствие ошибок не гарантируется. Возможны технические изменения. | Chyby a technické zmeny sú vyhradené! | Stand 9535